

Numerical and experimental hydrodynamic analysis of catamaran with and without V-like center bow

Peyman Ahmadi¹, Amin Najafi¹ and Seyed Mahmood Kheradmand, Mohamadreza Negahdari*²

¹ Department of Mechanical Engineering, Imam Hossein comprehensive University, Tehran, Iran

² Department of Marine Engineering, Chabahar University, Chabahar, Iran

ARTICLE INFO

Article History:

Received: 10 Apr 2022

Accepted: 02 Jan 2023

Keywords:

Catamaran

INCAT

V-like center bow

Vertical acceleration

slamming

ABSTRACT

Catamaran added V-like center bow (INCAT) is investigated as a wave-piercing vessel to decrease vertical acceleration and diminish slam events during sea-keeping operation. The catamaran and the vessel bow were modeled and the vertical acceleration of the model was validated with experimental test. The effect of using a V-like center bow for a catamaran vessel was explained numerically and experimentally considering two degrees of freedom of vessel motions. The results confirm the accuracy of the numerical model. Thus, the center bow geometry terms such as slope and elevation of the center bow from demi-hulls were optimized. The effect of three different slopes of the center bow, of models 1, 2, 3, on vertical acceleration were compared numerically and, thus the mild slope of 40 degrees was selected due to lower vertical acceleration.

The geometry of V-like center-bow such as the slope of the center bow and elevation from demi-hulls was optimized numerically in the case of 3 different slopes of the bow model. Considering different center bow elevation of 9.5 and 49.5 mm, the pressure contour of the INCAT vessels was compared numerically. The optimized INCAT vessel, and the catamaran vessel were tested in towing tank at two significant wave heights of 11 and 17 cm. Thus hydrodynamic parameters such as vertical acceleration, heave, and the resistance forces were measured and compared. The results show there is no slamming at a wave height of 11 cm but it occurs at a wave height of 17 cm.

1. Introduction

The slamming studies are highly noticeable for better sea-keeping and optimization of vessel performance. The vessel hydrodynamic is severely affected by slam event that is prevalent at the ship's center-bow. Hydrodynamic balance and body safety of vessels are faced with the risk of slam loads. The slam event investigations are complex and it has a non-linear stress behavior that exerts high local pressure on the ship structure such as beams and plates, generates undesirable vibrations, and diminishes the accuracy of operations. To avoid the above imperfections, wave-piercing catamarans (WPC), which have desirable capabilities such as passenger ferries, naval transport, and transportation of large payloads, have been constructed. The catamarans are usually in the range of 28 to 112 m of length and have

a body made of aluminum alloy. INCAT Tasmania is a world leader in building large high-speed Wave-Piercing Catamarans (WPC). The design style, that INCAT has adopted, is based on the use of center bows and surface-piercing demi-hulls. Using Center bow helps to keep buoyancy, avoid forward demi-hull underwater diving and offer low wet-deck height.

Slam load is an important hydrodynamic parameter which must be considered for WPCs design. Thus, optimization of the structural design of the vessel bow and forward demi-hull is extensively necessary to inhibit damage (G. Thomas et al., 2003). As the vessel moves in sea states, wetdeck slamming occurs. Structural vibrations called whipping are implemented by such wetdeck slamming especially in the vicinity of center bow truncation which is in contact with transient slam loads (G. Thomas et al., 2008, 2011; G.

A. Thomas et al., 2003). Structural vibrations of the catamaran and the modal analysis have been studied in the case of a high-speed light special catamaran to obtain a coming computation method of vibration characteristics (Li-ping et al., 2006). Davis et al. (2017) have mentioned slam event occurs due to wave impact to center bow and intensive pressure rise up on arch section. Numerical calculation is an effective way to characterize the hydrodynamic behavior of catamarans and it demands more attention consequently (Deng et al., 2010). The numerical analysis of slam load on vessels had been distributed in scientific research (Dessi, 2013; Dessi & Mariani, 2008; B. J. French, 2012; Matsubara, 2011; J. J. McVicar et al., 2016). To evaluate catamarans sea-keeping performance, experimental tests have been carried out, but it is desired to investigate numerical analysis instead of experimental analysis due to lower cost. Thus, modeling of the hydrodynamic performance of vessels is considerably attended (AlaviMehri et al., 2017; B. French et al., 2014; Lavroff et al., 2013; Nasserolelami et al., 2020; Souto-Iglesias et al., 2007; G. Thomas, 2009). Panahi et al. (2009) proposed a numerical simulation algorithm in the case of two-dimensional asymmetrical wedge slamming of a high-speed vessel. Zhou (2003) investigated the vorus's first order nonlinear theory for planning catamarans and compared it numerically with the second-order nonlinear theory. The results showed both theories had been incorporated with the design code of catamaran model. Rafie (2014) suggested both height and length parameters of the bow were noticeably effective on WPC behavior against slam load. Vicar (2016) reported a numerical model for estimating slam loads of a 2.5m hydroelastic segmented catamaran based on the 112m INCAT wave-piercer design. Hydrodynamic segmented catamaran models correlated well with both the direct experimental tests and the simulations and seem to be a suitable choice for further investigations. Karman (1929) carried out a series of experiments considering concept of added mass for determining maximum pressure on a floating vessel. Zhao (1993) investigated the water jet flow of a two-dimensional body of arbitrary cross-section with non-linear boundary element method. Furthermore, pressure distribution at wedge of body was calculated and verified by comparison with theoretical and experimental results. Varyani (2000) investigated catamaran motions as well as slam loads based on finite volume element and strip theory method. Grand (2009) investigated statistical distribution as well as applied pressure magnitude of slam event in the case

of two kinds of catamarans. Vorus (1996) described flat cylinder theory for analysis of impact loads on typical sections of vessels operating in waves, as well as the analogous hydrodynamics of steady planning in calm water. Additionally, the procedure is generalized to some of flat cylinder impacts. Afterward, geometrical variations of cylinder by time is taken in calculations. Noticeably, using a center bow and optimizing its hydrodynamic performance can evaluate the sea-keeping performance of catamarans. Whelan (2004) attended to effect of geometry of center bow on severity of slam impact.

Installation of a wave-piercing bow is an effective way for the evaluation of the sea-keeping capability of catamarans. Hydrofoils are used to decrease heave of catamarans, but they deal with stress concentration and damage body-bow joints during sea area operations. Accordingly, the installation of the center bow as an integrated segment to demi-hulls is proposed for such vessels. Optimization of center bow geometry is assumed outstanding in this field which is investigated experimentally in some studies but investigation of a numerical method still remains unresponsive. In the present study, numerical analysis of the catamaran vessel is carried out using CFD method, and the results are validated with experimental test. The center bow geometry terms such as slope and elevation from demi-hulls are investigated and optimized numerically. Thus the hydrodynamic parameters such as heave, pitch, and drag force are measured using ABAQUS software and the results are used to obtain best performance of different vessel models. Experimental test of the hydrodynamic performance of vessel is carried out and the occurrence of slamming load is investigated on a typical catamaran without or with V-like center bow (INCAT) at regular waves in head-sea condition. The aim of the study is an investigation of slam impact on both catamaran and INCAT vessel to better identification of sea-keeping conditions.

2. Methods and models

2.1 Hydrodynamic Catamaran Modeling

Hydrodynamic performance of catamaran is analyzed numerically using ABAQUS software. For optimizing the geometry of the V-like center bow, three different longitudinal slopes as mild, medium, and steep as well as two different elevations of center bow position are obtained. The assembly process of the center bow to demi-hulls is carried out using star ccm+ software and thus vessel is modeled in the full-scale model. Both V-like center bow and demi-hulls meshing are processed separately by which smaller meshing size of V-like center bow is required due to more variations of the hydrodynamic parameters in

the head-sea environment. All three V-like center bow models with mild, medium and steep longitudinal slopes have similar mesh sizes. By using K-ε turbulence model, CFD simulation is utilized.

Some of the main characteristics of the model condition are expressed in Table 1.

In order to study the effects of the body lines to obtain a appropriate body shape, the front part of the body is designed with three steep, medium and gentle slopes. Figure 2 and Table 2 show the type of models in this present study.

Table 1. Main characteristics of the model condition

Parameter	Parameter	Parameter	Parameter
I_{xx} (Kg.m ²)	22.09	Release time (sec)	0.3
I_{yy} (Kg.m ²)	3.89	Wavelength (λ), (m)	3
I_{zz} (Kg.m ²)	22.09	Wave height (ζ), (m)	0.2
Total weight (Kg)	40.32	Wave velocity (u), (m/s)	1.7
Time step (sec)	0.001	Air velocity (m/s)	1.7

For modeling the INCAT vessel, both demi-hulls positions are adjusted from the stern portion and fixed using metallic connectors. Fig. 1 represents the model design of the bow and demi-hulls of the INCAT vessel.

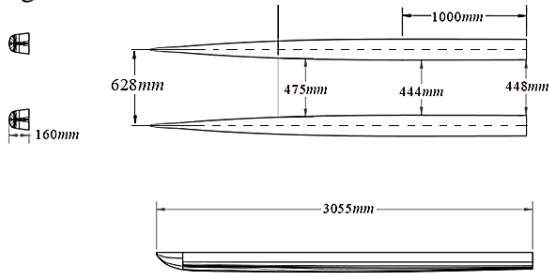

Figure 1. Top and side views of demi-hulls

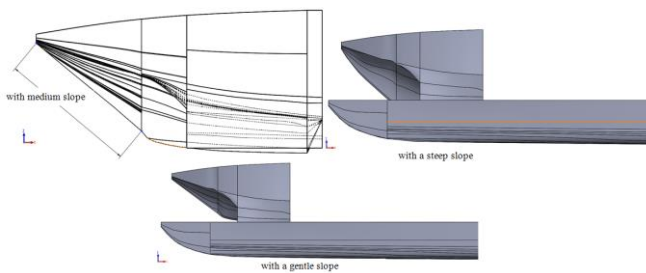

Figure 2. Type of hull designs with different slopes

Table 2: Type of models in this present study

Type of models	Description
Model 1	with a steep slope
Model 2	with a gentle slope
Model 3	with medium slope

2.2 Mesh independent solution

Vertical accelerations versus dimensions of computation domains were obtained to reach an optimum value as presented in Figure 3.

The fourth domain number would be selected which was confirmed by Iacono (2015). Dimensions of computation domains are described in Figure 4. Values of the 4th row of Table are selected in the case of optimum of dimensions of computation domains (Hudson et al., 2001).

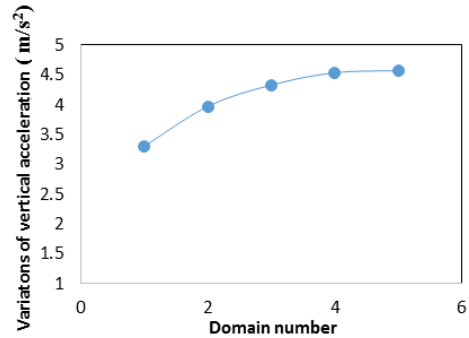

Figure 3. Independency of vertical acceleration from dimensions of computation domains

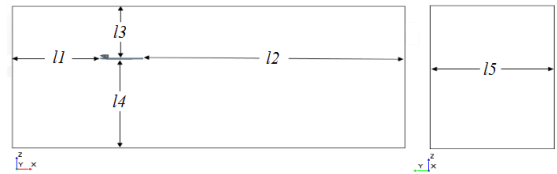

Figure 4. Different dimensions of computational domains based on Table

Table 3. Different dimensions of computation domains

	$l1$	$l2$	$l3$	$l4$	$l5$
1	l	$3.5l$	$0.75l$	$1.5l$	$1.25l$
2	l	$3.5l$	$0.75l$	$1.5l$	$2l$
3	$2l$	$4l$	l	$2l$	$2l$
4	$2l$	$6l$	$1.5l$	$2.5l$	$2.5l$
5	$2l$	$7l$	$1.5l$	$2.5l$	$3l$

2.3 Validation

Vertical acceleration of catamaran is investigated numerically and experimentally in regular waves as represented in Fig. 5. Numerical results on comparison with experimental illustrates the coordination of both plots together acceptably. Thus, the results validate the experiment. Besides, the comparison of results confirms the accuracy of the hydrodynamic conditions to analyze the catamaran motions numerically. The difference between the experimental and numerical results is due to the practical conditions in conducting the experiments in the present study. The confirmed conditions are also used for INCAT hydrodynamic problems. The procedures of hydrodynamic solvation are desirably approved in the case of both INCAT and catamaran.

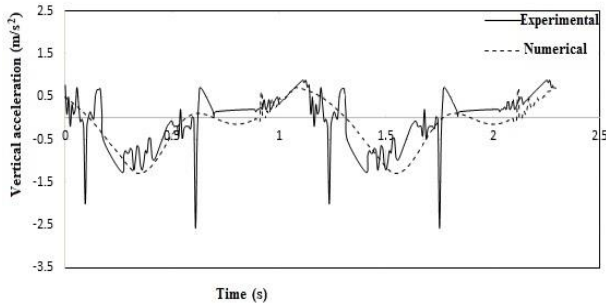

Figure 5. Experimental and numerical results in the wavy environment with $\zeta=6$ cm, $T=2$ sec, $u=1.62$ m/sec

3. Model correction of vessel

Fig. 6 represents the slop and elevation from demi-hulls of bow that these parameters are optimized for better sea-keeping performance of vessel.

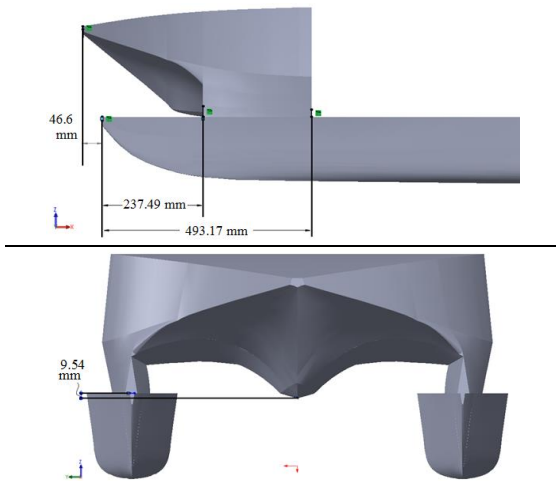

Figure 6. Top)side view of the catamaran, Bottom) elevation of center bow position from demi-hull

3.1 correction of body inclination

Table 4 represents resistance and vertical acceleration values in the case of different bow models. Results explain higher inclination of center bow leads to more resistance force due to more impact of water and the center bow. In order to optimize center bow performance, lower vertical acceleration and lower resistance force are needed possibly. In the case of model 2, the lowest vertical acceleration is measured but the resistance force is rather more than model 3 and lower than model 1. Therefore, model 2 is selected to have the best performance from three bow models.

Table 4. INCAT resistance force and vertical acceleration for different V-like center bow models at the center of mass

Model	Slope (Deg.)	Resistance force (N)	Vertical acceleration (m/s^2)
Model 1	47	41.25	4.69
Model 2	40	38.59	4.55
Model 3	36	37.52	4.73

3.2 Elevation of center bow correction

After correction of vertical acceleration in the case of model 2, the elevation of bow is investigated for models 4 and 5 with elevation of 49.5 and 9.5 mm, respectively.

3.2.1 Vertical acceleration comparison of models

In order to investigate the effect of the height parameter of the center bow on vertical acceleration, two different vertical elevations between center bow bottom and demi-hulls upward surface are chosen according to

Table 5. Vertical acceleration is reduced by approximately 4% in model 5 which is selected as an optimized distance term. Variation of the vessel vertical acceleration depends on applied pressure to center bow and demi-hulls. Vertical acceleration increases as applied pressure on vessel body increase.

Table 5. Height of center bow position and the relevant vertical acceleration

V-like center bow model	Vertical elevation (mm)	Vertical acceleration (m/s^2)
Model 4	9.5	1.65
Model 5	49.5	1.59

Figure7 describes variations of vertical acceleration in model 5 in comparison to model 4. The model 5 plot represents lower vertical acceleration.

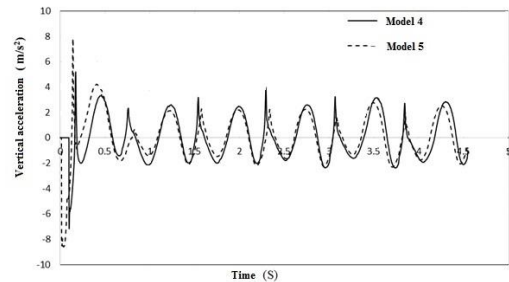

Figure 7. Vertical acceleration variations of INCAT vessel with the different vertical elevation of bow position versus time in numerical simulation

Contacts of free surface and vessel body cause to exert pressure on center bow and demi-hulls as represented in Fig. 8. The pressure contours describe the highest pressure values are exerted on center bow truncation.

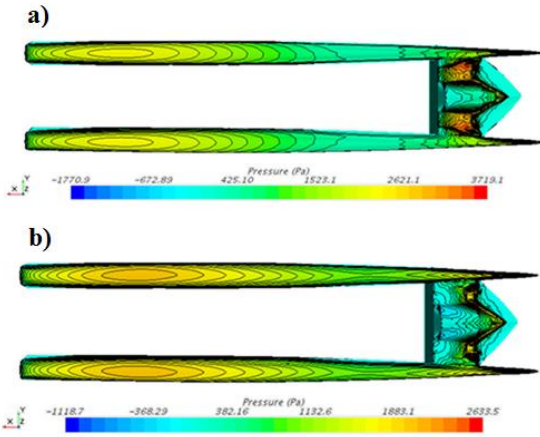

Figure 8. Pressure contours around the INCAT vessels a) model 4 at $t=2.297$ sec, $a_{max}=3.945$ m/s² b) model 5 at $t=2.343$ sec, $a_{max}=2.231$ m/s²

The pressure contour also confirms higher pressure values in the case of model 4 center bow truncation than model 5 due to the lower elevation of bow position. Noticeably, comparison of pressure contours of demi-hulls of both vessels explains higher applied pressure values in model 5 that is attributed to wave impact to both demi-hulls due to higher elevation of V-like center bow. In other hands, more pressure is exerted on model 5 demi-hulls compared with model 4 so that decrease of exerted pressure on the center bow is acceptable considering the same wavy environment, thus the decrease of vertical acceleration is carried out by two steps that can be described as wave impact to demi-hulls before the center bow and afterward wave impact to bow. In other words, the demi-hulls act as a pressure reducer for the center bow. Additionally, the contour of model 4 displays higher and lower exerted pressure on demi-hulls and V-like center bow respectively in comparison to model 5. Higher exerted pressure on model 4 center bow coordinates with lower exerted pressure on demi-hulls. As the INCAT moves in a wavy environment, demi-hulls are exposed to the free surface but not V-like center bow because of the relatively high vertical elevation of the bow from demi-hulls. Wave loads imparted to model 4 truncation should be taken into consideration for designing and fabrication of vessels necessarily.

3.3 Effect of elevation of center bow position on angular acceleration variations

Like vertical acceleration, other hydrodynamic parameters are also affected by the elevation parameter. Variations of angular acceleration around the y-axis versus time are shown in Figure 9. As the elevation of center bow increases, the vertical acceleration of vessel would decrease.

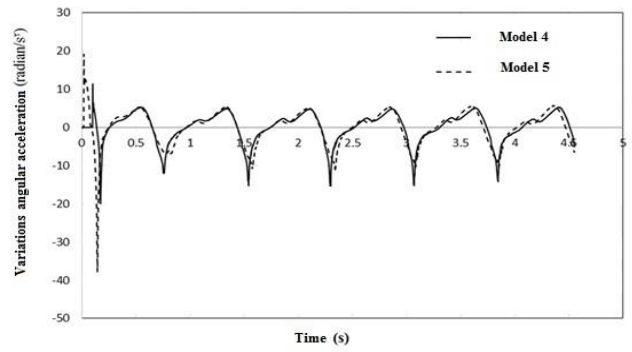

Figure 9. Variations of angular acceleration around y-axis versus time

3.4 Comparisons of resistance force of models

A decrease of elevation concludes to an increase of resistance force as mentioned for model 4. Using the K- ϵ method, resistance force variations depend on y plus (y^+) criteria which have an acceptable range value below 100. One of the most prominent parameters when judging the applicability of wall functions is the so-called dimensionless wall distance y^+ . However, using boundary layer thickness values properly, y^+ plus contour of the vessel is shown in Figure 10.

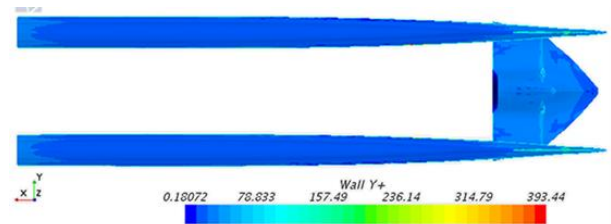

Figure 10. Y plus contour at $t= 4$ sec

Average y^+ plus value is calculated about 70 and the resistance forces are obtained 26.72 and 25.89 N for models 4 and 5 INCAT vessel respectively as represented in Figure 11.

Total resistance force is attributed to resistances due to vessel contact with air and water. The dense environment concludes to more resistance force so contact between vessel body and free surface is more effective on the quantity of total hydrodynamic resistance. Furthermore, the higher elevation of the center bow position leads to a reduction of the probable impact of water during operation and obviously comes into lower resistance as mentioned in the case of model 5 INCAT vessel performance. The resistance force of model 4 and 5 vessels are 26.71 and 25.88 N respectively that the results represent a lower drag force of 3.1% and better performance in the case of Model 5.

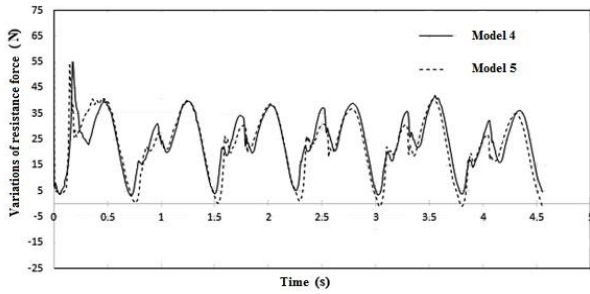

Figure 11. Resistance force variations of model 4 and 5 INCAT vessel

3.5 Effect of elevation of center bow position on the pitch

Concerning model 4, the maximum pitch values of model 5 are increased up to 3.1% due to the increase of elevation of center bow position as shown in Figure 12. Root mean square (RMS) of the pitch parameter in the case of models 4 and 5 are calculated 2.82 and 2.89 degrees, respectively. The variation of domain of the plot will increase with the increase of center bow elevation. The water surface impact to bow decreases with increase of center bow elevations and it leads to an increase of vessel motion domain as pitch and heave.

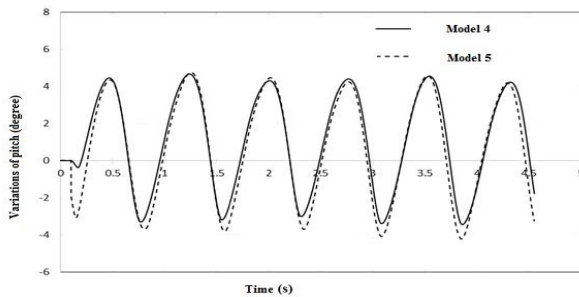

Figure 12. Pitch variations of models 4 and 5 of INCAT vessel versus time

3.6 Effect of elevation of center bow position on heave

The variations of heave are represented in Figure 13 which maximum values are 8.98 and 9.45 cm respectively for models 4 and 5. The increase of elevation of center bow position tends to increase of heave variation. The increase of variations of heave and pitch corresponds with the decrease of resistance force for model 5.

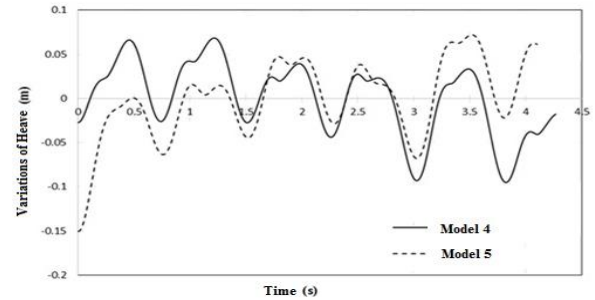

Figure 13. Variation of heave of model 4 and 5 INCAT vessel

3.7 Pressure contour on demi-hulls

Elevation of the center bow position is optimized for obtaining lower vertical acceleration, thus the model 5 is investigated for the contact between water and demi-hulls. As the center bow is entered in the water environment, the water column rises up in the vicinity of demi-hulls. The V-like design of center bow causes the diminishing of impact-induced by water on the body and reduction of vertical accelerations. The smooth curve of the V-like center bow leads to a uniform distribution of applied pressure on the truncation and also a reduction of vertical acceleration. When the center bow is in contact-free condition with the free surface, the most impressed zone is located in the bottom portion of demi-hulls as illustrated in Figure 14. In the next steps, with rising up the contacts between the center bow and free surface, the high-pressure zone on demi-hulls relocates toward stern.

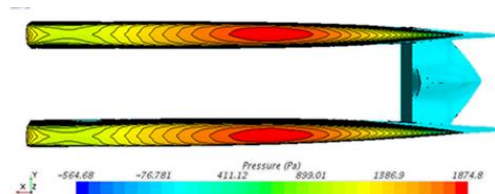

Figure 14. Pressure contour of bottom structure of model 5 INCAT vessel without center bow-free surface contact

4. Experimental investigation

The vessel was fabricated and provided for a towing-tank experiment as the following descriptions. Center of mass was considered according to model design and thus the mass balance is gained using weight tools jointed to vessel. In order to investigate hydrodynamic variations, a dynamometer is situated at the center of mass of catamaran. Both nylon cloth and heat resistive resin are used to seal dynamometer and joining it to vessel. Heave, pitch, and other parameters are measured using a digital accelerometer situated at the vessel center of mass.

A foam mold, which is covered with three-layered 90-degree array UD-160 carbon fiber and with layered

cotton, is provided for casting the V-like center bow. The carbon fiber density is about 0.16 Kg/m^3 . The bow body is finally painted in order to protection and beauty advantages. Fore and aft trim positions are determined. The catamaran is jointed to towing carriage from the joint point for towing operation. Some of the used apertures are described in Table 6.

Table 6. Catamaran vessel capabilities

Aperture	Capability
Accelerometer (g)	10
Altimeter (mm)	± 300
Wave profiler (mm)	$\pm \pm 500$
Dynamometer, resistance measurement (N)	600
Camera	Underwater high speed
Laser Rangefinder (m)	200
Inclinometer (degree)	± 90
Towing joint point distance from the stern (cm)	124
Stern length (cm)	9.7
Draft forward mark distance from the stern (cm)	197
Draft aft mark distance from the stern (cm)	73

4.1 Test condition

The maneuverability performance of catamaran is investigated using the JONSWAP sea spectrum for a test environment with significant wave height of 11 and 17 cm. Table 7 describes some test conditions.

Table 7. Conditions of towing tank test

Parameter	Value
Carriage speed (m/s)	1.7
Significant wave height, $H_{1/3}$ (cm)	11, 17
Degree of freedom	2 (Heave, Pitch) Catamaran
Type of vessel	Catamaran added V-like center bow (INCAT)
Wave simulation	JONSWAP sea spectrum

Fig. 15 shows the INCAT vessel and catamaran before the towing tank test.

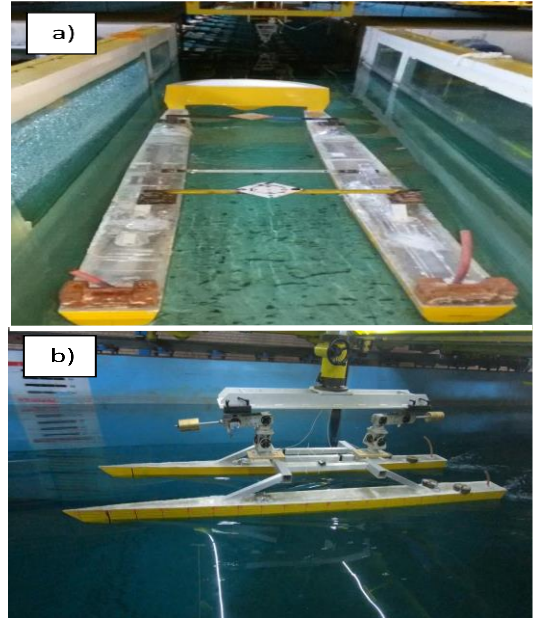

Figure 15. INCAT vessel before towing tank test b) Preparing catamaran for test

4.2 Investigation effect of adding vessel bow on vertical acceleration at center of mass

4.2.1 Wave height of 11 cm

First, the experimental test is carried out to investigate catamaran and INCAT vessels in a wavy environment with a significant wave height of 11 cm. The vertical acceleration of both vessels is represented in Fig 16. A comparison of vertical acceleration variations of both vessels illustrates a noticeable reduction of up to 51% in the case of INCAT vessel as shown in Table 8. Furthermore, the results describe a lack of slam events. The existence of a V-like center bow provides rather enough buoyancy in the wavy environment thus it helps to pierce waves and inhibit INCAT vessels from surfing on waves.

Table 8. Experimental vertical acceleration values at the center of mass ($\xi=11 \text{ cm}$)

	Catamaran	INCAT
RMS of vertical acceleration (m/s^2)	1.60	0.78
Maximum acceleration (m/s^2)	7.64	6.30
Minimum acceleration (m/s^2)	-7.60	-6.84

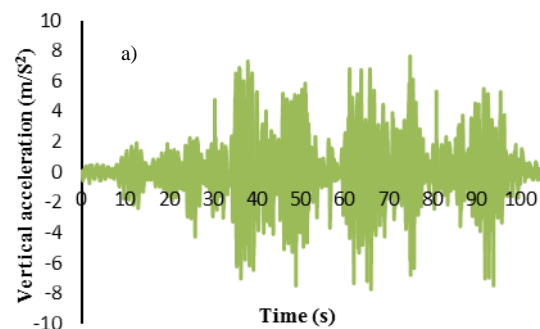

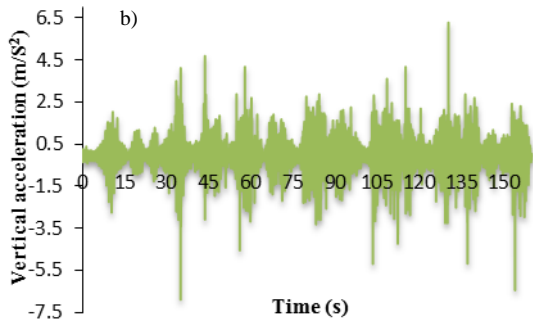

Figure 16. Variations of vertical acceleration of a) catamaran b) INCAT at the center of mass in experimental test ($\zeta=11$ cm)

4.2.2 Wave height of 17 cm

Fig 17 and Table 9 verify occurrences of slamming in the head-sea condition of 17 cm significant wave height. The Maximum and minimum vertical acceleration of the INCAT vessel show a value significantly more than catamaran which emphasizes the role of the bow. Lower vertical acceleration reduction occurs approximately 20% when the higher significant wave height is investigated. In other words, as the significant wave height increases to 17 cm, slamming occurs that it might diminish the advantage of the conjunction of a V-like center bow to the catamaran.

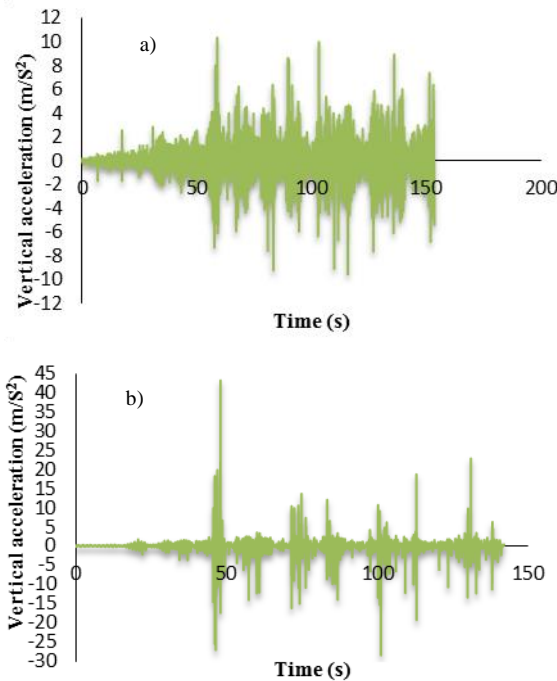

Fig. 17. Variations of vertical acceleration of a) catamaran b) INCAT at the center of mass in experimental test ($\zeta=17$ cm)

Table 9. Experimental vertical acceleration values at the center of mass ($\zeta=17$ cm)

	Catamaran	INCAT
RMS of vertical acceleration (m/s ²)	1.76	1.40

Maximum vertical acceleration (m/s ²)	10.36	42.87
Minimum vertical acceleration (m/s ²)	-9.47	-28.54

4.3 Investigation effect of adding vessel bow on pitch at center of mass

4.3.1 Wave height of 11 cm

Figure 18 describes a significant reduction of pitch even more than 50% which was observed in the case of vertical acceleration parameter. Two main parameters such as significant wave height and slam load affect pitch angle variations, so adding a bow to catamaran provides stability for vessel motion, which decreases pitch and vertical acceleration. Table 10 and 11 describes the resulted experimental pitch values.

Table 10. Experimental pitch values at the center of mass ($\zeta=11$ cm)

	Catamaran	INCAT
RMS of pitch (deg.)	0.39	0.13
Maximum pitch (deg.)	1.79	0.57
Minimum pitch (deg.)	-2.55	-0.49

Table 11. Experimental pitch values at the center of mass ($\zeta=11$ cm)

	Catamaran	INCAT
RMS of pitch (deg.)	0.39	0.13
Maximum pitch (deg.)	1.79	0.57
Minimum pitch (deg.)	-2.55	-0.49

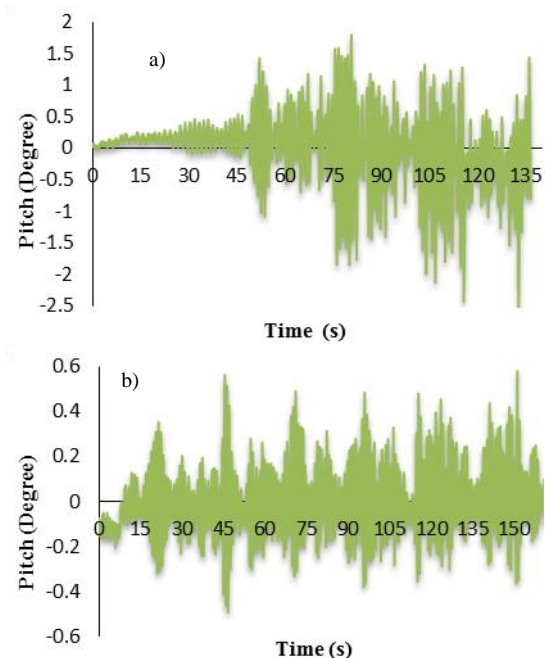

Figure 18. Variations of pitch a) catamaran b) INCAT at the center of mass in the experimental test ($\zeta=11$ cm)

4.3.2 Wave height of 17 cm

Minimum and maximum values of the pitch of the INCAT vessel exceed catamaran at the center of mass

but RMS value of pitch of INCAT is lower. Variations of pitch value plots are represented in Fig. 19 in the case of both catamaran and INCAT. The reduction of RMS values is attributed to the added wave-piercing vessel bow but slam event increases this value. Experimental results are shown in Table 12.

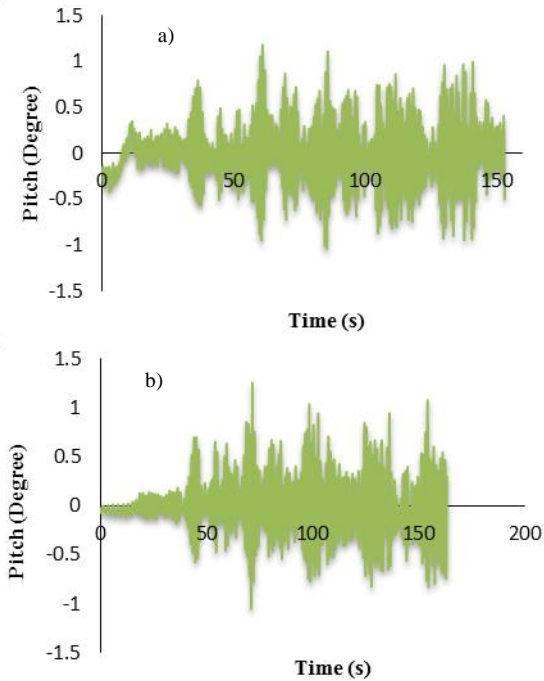

Figure 19. Variations, of pitch a) catamaran b) INCAT at the center of mass in the experimental test ($\zeta=17$ cm)

Table 12. Experimental pitch values at the center of mass ($\zeta=17$ cm)

	Catamaran	INCAT
RMS of pitch (deg.)	0.28	0.25
Maximum pitch (deg.)	1.18	1.25
Minimum pitch (deg.)	-1.02	-1.05

4.4 Investigation effect of adding vessel bow on heave at center of mass

4.4.1 Wave height of 11 cm

Average of heave value in the case of INCAT vessel exceeds the average value of catamaran that is attributed to the existence of bow as described in Table 13. Hence, RMS of heave shows an approximately 18.8% reduction in the case of INCAT vessel compared to the catamaran that leads to lower motions of INCAT. Furthermore, the decrease of the heave of the INCAT vessel is represented in Fig. 20.

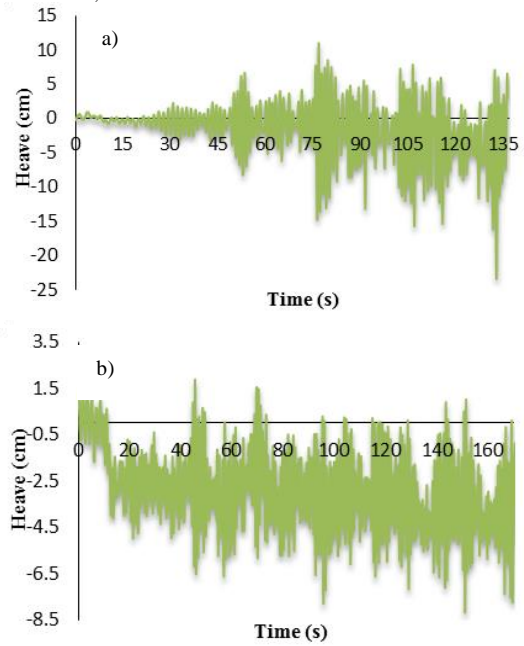

Figure 20. Variations of heave a) catamaran b) INCAT at the center of mass in the experimental test ($\zeta=11$ cm)

Table 13. Experimental heave values at the center of mass in the environment ($\zeta=11$ cm)

	Catamaran	INCAT
RMS of heave (cm)	4.08	3.31
Average of heave (cm)	-1.56	-2.90
Maximum heave (cm)	10.90	1.86
Minimum heave (cm)	-23.47	-8.20

4.4.2 Wave height of 17 cm

Variation of heave values is represented in Fig. 21. As mentioned for pitch values of 11cm wave height, RMS of heave is decreased by about 10% according to Table 14.

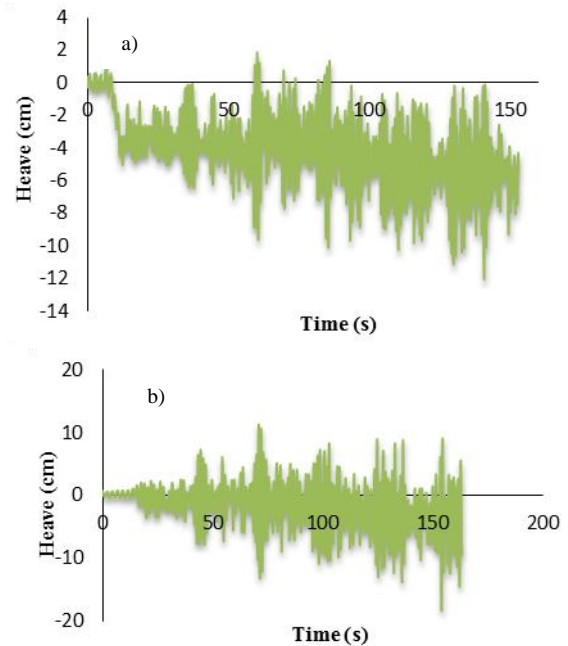

Figure 21. Variations of resistance force a) catamaran b) INCAT at the center of mass in the experimental test ($\zeta=17$ cm)

Table 14. Experimental heave values at the center of mass ($\zeta=17$ cm)

	Catamaran	INCAT
RMS of heave (cm)	4.59	4.11
Average of heave (cm)	- 4.06	- 1.62
Maximum heave (cm)	1.80	11.27
Minimum heave (cm)	- 12.07	- 18.33

4.5 Investigation effect of adding vessel bow on resistance force at center of mass

4.5.1 Wave height of 11 cm

Adding a bow to catamaran increases heave motions as well as contacts between vessel body and free surface thus increase of resistance force is obtained in the case of INCAT vessel as represented in Table 15 and Fig. 22.

Table 15. Experimental resistance force at the center of mass ($\zeta=11$ cm)

	Catamaran	INCAT
RMS of resistance force (N)	20.21	21.36
Maximum resistance force (N)	106.41	105.43
Minimum resistance force (N)	-32.05	-84.43

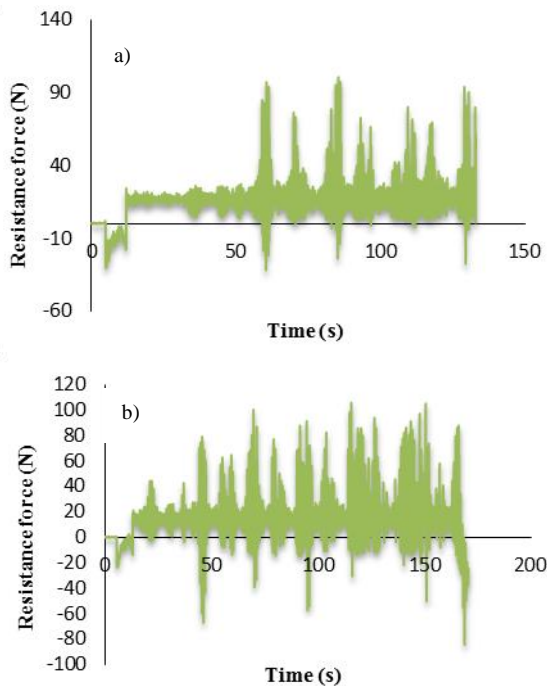

Figure 22. Variations of resistance force a) catamaran b) INCAT at center of mass in the experimental test ($\zeta=11$ cm)

4.5.2 Wave height of 17 cm

INCAT vessel resistance force is more than catamaran about 6% as represented in Table 16. Thus, the addition of bow increases resistance force but decreases vertical acceleration by about 20 percent. Variations of resistance force are represented in the 17 cm wave height environment.

Table 16. Experimental resistance force values at the center of mass ($\zeta=17$ cm)

	Catamaran	INCAT
RMS of resistance force (N)	39.25	41.82
Maximum resistance force (N)	224.59	358.51
Minimum resistance force (N)	-185.61	-151.56

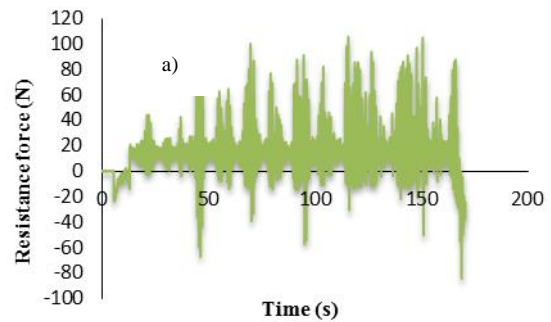

Figure 23. Variations of resistance force a) catamaran b) INCAT at center of mass in the experimental test ($\zeta=17$ cm)

Vertical acceleration is decreased by 55.5% in the case of INCAT vessel and resistance force is increased by 5.7%. In our work, reduction of vertical acceleration is preferred to the reduction of resistance force thus using an INCAT vessel has priority in the wavy environment with 11cm significant wave height due to lower vertical acceleration. In other words, an increase in energy consumption due to an increase of resistance is not taken into consideration inevitably that is related to our requirements and working conditions.

5. Conclusion

The effect of using a V-like center bow for a catamaran vessel was investigated numerically and experimentally considering two degrees of freedom of vessel motions. The results confirm the accuracy of the numerical model. Thus, the center bow geometry terms such as slope and elevation of the center bow from demi-hulls were optimized. The effect of three different slopes of the center bow, of models 1, 2, 3, on vertical acceleration were compared numerically and, thus the mild slope of 40 degrees was selected due to lower vertical acceleration. Furthermore, two different vertical elevations of the center bow from demi hulls of models 4 and 5 were compared numerically that the results show vertical acceleration decreases from 1.65 to 1.59 m/s^2 with the increase of elevation of bow position from 9.5 to 49.5 mm but increase of heave and pitch occurs. Besides, the pressure contours represented more exerted pressure on the center bow in the case of model 4.

Hydrodynamic performance of vessels experimentally was tested that the results are mainly

described as below:

- No slam event had occurred in the environment with a wave height of 11 cm. Besides, results showed vertical acceleration as well as pitch and heave decreased but resistance force increased in the case of INCAT vessel.

- Slam event was investigated in an environment with a 17 cm wave height. Vertical acceleration, as well as heave and pitch, decreased but absolutely the value of maximum and minimum of pitch and heave as well as resistance force increased in the case of INCAT vessel.

Noticeably, the effect of adding a bow to the vessel is completely dependent on wave sea conditions. Other wave sea conditions can be subjected for further studies.

6. References

- AlaviMehri, J., Lavroff, J., Davis, M. R., Holloway, D. S., & Thomas, G. A. (2017). An experimental investigation of ride control algorithms for high-speed catamarans Part 1: Reduction of ship motions. *Journal of Ship Research*, 61(1), 35–49.
- Davis, M. R., French, B. J., & Thomas, G. A. (2017). Wave slam on wave piercing catamarans in random head seas. *Ocean Engineering*. <https://doi.org/10.1016/j.oceaneng.2017.03.007>
- Deng, R., Huang, D., Li, J., Cheng, X., & Yu, L. (2010). Discussion of grid generation for catamaran resistance calculation. *Journal of Marine Science and Application*, 9(2), 187–191. <https://doi.org/10.1007/s11804-010-9080-2>
- Dessi, D. (2013). Reconstruction of the experimental slamming force distribution based on POD. *International Conference on Offshore Mechanics and Arctic Engineering*, 55430, V009T12A057.
- Dessi, D., & Mariani, R. (2008). Analysis and prediction of slamming-induced loads of a high-speed monohull in regular waves. *Journal of Ship Research*, 52(1), 71–86.
- French, B. J. (2012). *Slamming of large high-speed catamarans in irregular seas*. University of Tasmania.
- French, B., Thomas, G. A., & Davis, M. R. (2014). Slam characteristics of a high-speed wave piercing catamaran in irregular waves. *Royal Institution of Naval Architects. Transactions. Part A. International Journal of Maritime Engineering*, 156(Part A1), A25--A36.
- Grande, K., & Xia, J. (2009). Prediction of slamming occurrence on catamaran cross structures. *ASME 2002 21st International Conference on Offshore Mechanics and Arctic Engineering*, 525–533.
- Hudson, D., Molland, A., Price, W. G., & Temarel, P. (2001). Seakeeping performance of high speed catamaran vessels in head and oblique waves. *Proceedings of the Sixth International Conference on Fast Sea Transportation (FAST 2001)*, Southampton, England, 1, 247–257.
- Iacono, M. (2015). *Hydrodynamics of Planing Hull by CFD*. Napels Federico II.
- Lavroff, J., Davis, M. R., Holloway, D. S., & Thomas, G. (2013). Wave slamming loads on wave-piercer catamarans operating at high-speed determined by hydro-elastic segmented model experiments. *Marine Structures*. <https://doi.org/10.1016/j.marstruc.2013.05.001>
- Li-ping, S., Wu, N., & Wei, Z. (2006). Analysis of structural dynamic characteristics of a high speed light special catamaran. *Journal of Marine Science and Application*, 5(1), 1–5. <https://doi.org/10.1007/s11804-006-0040-9>
- Matsubara, S. (2011). *Ship motions and wave-induced loads on high speed catamarans*. The University of Tasmania.
- McVicar, J. J., Lavroff, J., Davis, M. R., & Thomas, G. A. (2016). Slam excitation scales for a large wave piercing catamaran and the effect on structural response. *Transactions-Society of Naval Architects and Marine Engineers*, 123, 442–451.
- McVicar, J., Lavroff, J., Davis, M. R., & Davidson, G. (2016). Transient slam load estimation by RANSE simulation and by dynamic modeling of a hydroelastic segmented model. *The 30th Symposium on Naval Hydrodynamics*, 1–16.
- Nasserolelami, A., Sarreshtehdari, A., & Salari, M. (2020). Numerical Study of the Hydrodynamic Pressure Field Generated due to Ship Motion at Different Speeds. *Journal of Applied Fluid Mechanics*, 13, 1575–1586.
- Panahi, R., Jahanbakhsh, E., & Seif, M. S. (2009). Towards simulation of 3D nonlinear high-speed vessels motion. *Ocean Engineering*, 36(3–4), 256–265.
- Rafie Shahraki, J. (2014). *The influence of hull form on the slamming behaviour of large high-speed catamarans*. University of Tasmania.
- Souto-Iglesias, A., Zamora-Rodríguez, R., Fernández-Gutiérrez, D., & Pérez-Rojas, L. (2007). Analysis of the wave system of a catamaran for CFD validation. *Experiments in Fluids*, 42(2), 321–332.
- Thomas, G. (2009). The vibratory response of high-speed catamarans to slamming investigated by hydroelastic segmented model experiments. *Transactions of the Royal Institution of Naval Architects Part A: International Journal of Maritime Engineering*, 151, 1–13. <https://doi.org/10.3940/rina.ijme.2009.a4.159>
- Thomas, G. A., Davis, M. R., & Holloway, D. S. (2003). The whipping vibration of large high

Peyman Ahmadi et al. / Numerical and experimental hydrodynamic analysis of catamaran with and without V-like center bow speed catamarans. *International Journal of Maritime Technology*, 145, 289–304.

Zhou, Z. (2003). *A theory and analysis of planing catamarans in calm and rough water*.

- Thomas, G., Davis, M., Holloway, D., & Roberts, T. (2008). The vibratory damping of large high-speed catamarans. *Marine Structures*, 21, 1–22. <https://doi.org/10.1016/j.marstruc.2007.12.003>
- Thomas, G., Davis, M., Holloway, D., Watson, N. L., & Roberts, T. J. (2003). Slamming Response of a Large High-Speed Wave-Piercer Catamaran. *Marine Technology*, 40, 126–140.
- Thomas, G., Winkler, S., Davis, M., Holloway, D., Matsubara, S., Lavroff, J., & French, B. (2011). Slam events of high-speed catamarans in irregular waves. *Journal of Marine Science and Technology*, 16, 8–21. <https://doi.org/10.1007/s00773-010-0105-y>
- Varyani, K. S., Gatiganti, R. M., & Gerigk, M. (2000). Motions and slamming impact on catamaran. *Ocean Engineering*, 27(7), 729–747.
- Von Karman, T. (1929). *The impact on seaplane floats during landing*.
- Vorus, W. S., & others. (1996). A flat cylinder theory for vessel impact and steady planing resistance. *Journal of Ship Research*, 40(02), 89–106.
- Whelan, J. R. (2004). *Wetdeck slamming of high-speed catamarans with a centre bow*. University of Tasmania.
- Zhao, R., & Faltinsen, O. (1993). Water entry of two-dimensional bodies. *Journal of Fluid Mechanics*, 246, 593–612.