



## Research Article

## PROVIDING A MINIMUM DEFECTIVENESS OF INTER-TURN INSULATION AT THE MANUFACTURING STAGE AND DURING THE EXPLOITATION

A.P. Leonov<sup>1\*</sup>, A. Supueva<sup>2</sup>

<sup>1</sup> National Research Tomsk Polytechnic University,  
30, Lenin avenue, Tomsk, 634050, Russia

<sup>2</sup> Kyrgyz State University of Construction Transport and Architecture n. a. N. Isanov,  
34 b, Malybaeva st., Bishkek, 720020, Kyrgyz Republic

---

### Abstract

The reliability of a low-voltage asynchronous electric motor is primarily determined by the reliability of the stator winding insulation. Common reasons for the failure of the insulation system are the unsatisfactory quality of the enameled wires and electrical insulating materials used for imperfection and violation of the technological process of winding and insulating work, and the discrepancy between operating modes. In the vast majority of cases, failures occur due to damage to the inter-turn insulation as the weakest element. This causes the need to study the insulation system resistance to the formation of defects. The results of assessing the stability of the insulation of winding wires to defect formation are obtained, taking into account the features of the operational loads characteristic of frequency-controlled drives with pulse-width modulation of the output voltage and the influence of the inter-turn insulation defectiveness level on its reliability indicators is also studied. The authors have developed the measures to reduce the defectiveness of inter-turn insulation at the manufacturing stage and during operation. This will ensure a minimum level of insulation defects and increase the resource of asynchronous electric motors by reducing the number of failures.

*Keywords:* Enameled wire, inter-turn insulation, defectiveness, low-voltage winding, asynchronous motor, frequency-controlled drive, reliability.

---

### 1. Introduction

Low-voltage induction motors remain by far the most common and widely used type of electrical machine. Despite many works devoted to improving the quality and increasing the reliability of these devices, operational statistics show that 20–25 % of installed electric motors undergo major repairs annually. Failure of electric motors occurs due to the loss of the insulation system during the exploitation [1–4].

The weakest component of the insulation system of asynchronous electric motors is inter-turn, which is the  $n$ -th number of conductors coated with a layer of enamel insulation, between the turns of which there is an impregnating composition that fills the voids between the wires. The presence of through defects leads to insulation breakdown. The higher the probability of an inter-turn short circuit, the greater the number of damages [2, 5, 6].

Ensuring the minimum level of defectiveness of inter-turn insulation is possible only with an integrated approach that considers the assessment of the presence of defects in the enamel insulation of the winding wire in the state of delivery, the possibility of defects during technological impacts, as well as their appearance during electric motor operation.

---

\* Corresponding authors: Leonov A.P.

E-mail: [leonov\\_ap@tpu.ru](mailto:leonov_ap@tpu.ru)

☆ Peer review under responsibility of Tomsk Polytechnic University.

<https://doi.org/10.18799/24056529/2022/1/320>

The main reason for defects in the insulation is the insufficient mechanical strength of the enamel coating to technological and operational factors [1, 7, 8]. Therefore, it is essential to identify and exclude wires with low resistance to the above loads at the initial stage.

**Experiment (Methodical part)**

The principal modern standard methods for determining the mechanical strength of the insulation of enameled wires are to assess the resistance to abrasion by a needle under an ever-increasing load [9] and to determine the number of double strokes of the hand along the surface of the wire before abrasion of the enamel insulation [10]; as well as electrical strength – by the magnitude of the breakdown voltage  $U_{br.h}$

In this work, the properties of enameled wires were studied (Table 1) using the methods recom-

mended by various regulatory documents [9–11]. The results are presented in Fig. 1–3, Table 2.

**Table 1.** Description of the brands of the investigated enameled wires

Type of wire	Heat resistance class	Type of enamel insulation
Type 1*	F	Polyetherimide enamel
Type 2	H	Double insulation made of polyesterimide and polyamideimide enamel
Type 3	F	Polyetherimide enamel
Type 4	C	Polyamideimide enamel
Type 5	B	Polyester enamel
Type 6	H	Double insulation made of trihydroxyethyl cyanurate varnish (contains 0,1 vol. % silica nanoparticles) polyamideimide enamel

\*Aluminum conductor.

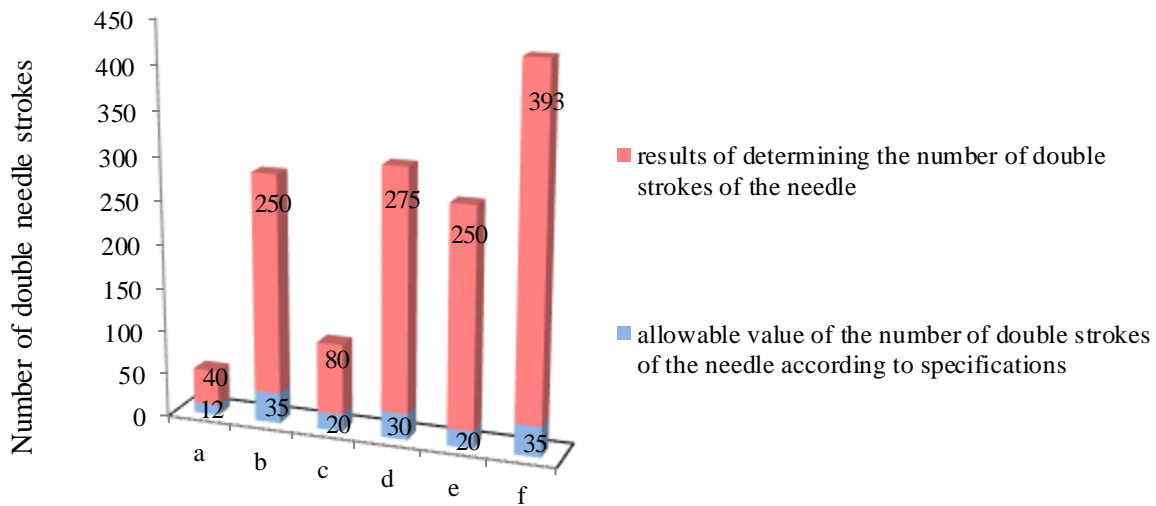

**Fig. 1.** Resistance to abrasion of enamel insulation of wires under constant load: a) type 1\*; b) type 2; c) type 3; d) type 4; e) type 5; f) type 6

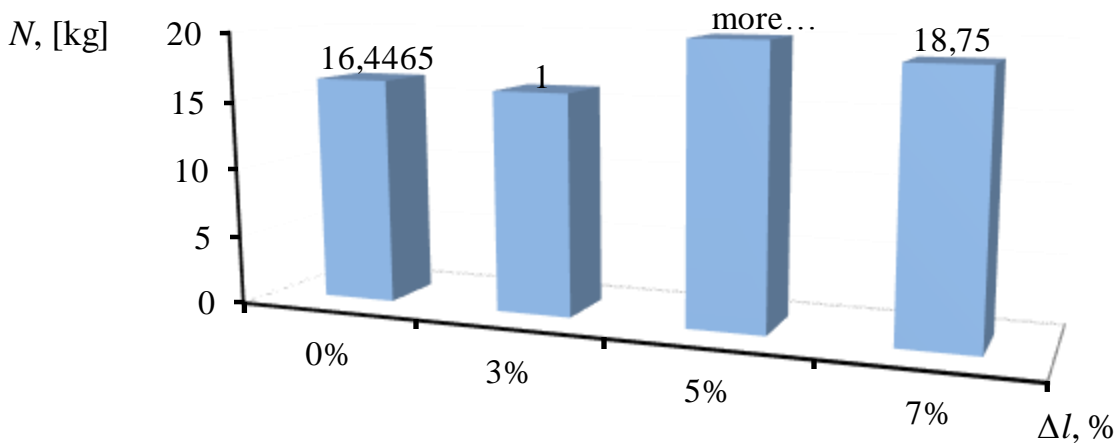

**Fig. 2.** Abrasion resistance of the enamel insulation of wire type 1 under constantly increasing load (permissible load limit  $N$  is 4,5 kg)

**Table 2.** Influence of wire stretching on insulation resistance to abrasion under constant load

Type of wire	Parameter	Number of double strokes of the needle N on the surface of the insulation			
		Sample elongation, %			
		0	3	5	7
Type 1*	Change interval	15÷62	19÷55	14÷53	19÷59
	Mean	40	28	30	33
Type 2	Change interval	270÷130	284÷102	25÷164	27÷372
	Mean	250	203	64	159
Type 3	Change interval	24÷226	22÷197	6÷61	23÷128
	Mean	80	74	39	56

\*Aluminum conductor.

The method based on determining the number of double strokes of the needle before insulation wear [9] is characterized by the low statistical stability of the results. This is evidenced by a wide range of data obtained (Table 2). It is important to note that the wires are tested only in the delivered condition.

During production a noticeable winding of wires is felt by stretching when winding, abrasion of the surface when laying, and bending, which can reduce the mechanical reliability of transmission. The results of experiments with long-discovered conductor samples are confirmed. With the increase in the relative elongation of the sample, the number of double strokes of the needle along the surface of the wire may decrease until the insulation is destroyed (Table 2).

The recommended IEC 60851-3-2002 [10] assessment of the liver resistance to abrasion with con-

stantly increasing density is somewhat arbitrary since the result is presented in the «yes»–«no» format (damage to the enamel film occurred or not). All tested wires passed successfully (for example, Fig. 2 shows the data for type 1 wires; the insulation of other wire brands passed the test without destruction).

The essential drawback of the existing standard methods for assessing mechanical properties [9, 10] is the small test area of the sample. This negatively affects the accuracy and reliability of the results obtained since enamel insulation is characterized by a considerable heterogeneity of properties along the length of the wire. In addition, the criteria used are conditional, uninformative, and ultimately do not allow considering the change in defectiveness.

Controlling the breakdown voltage  $U_{br}$  makes it possible to identify wires with low electrical strength. However, the results only state the presence or absence of insulation destruction without analyzing the processes leading to destruction. In this regard, the breakdown voltage cannot be taken as a criterion for the insulation resistance to the appearance of defects, despite the direct relationship between damage in the insulation and the breakdown voltage  $U_{br}$ .

The results of the experimental data (Fig. 3) only allow us to note: that the enamel insulation of all the wires under study has sufficient electrical strength. Since a change in the breakdown voltage is a consequence of the mechanical destruction of the insulation, the primary attention in determining the properties should be given to mechanical strength.

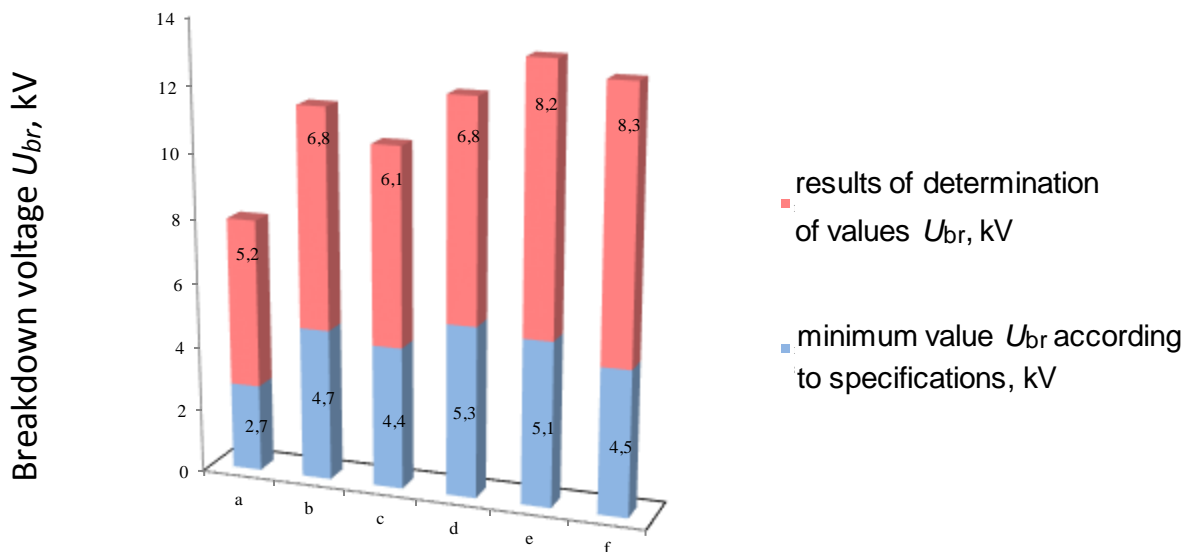

**Fig. 3.** Average values of breakdown voltages of enamel insulation of wires: a) type 1; b) type 2; c) type 3; d) type 4; e) type 5; f) type 6

An accurate qualitative and quantitative assessment of the enamel insulation resistance to the acting loads is provided by determining the defectiveness of the electrolyte (Tables 3, 4) [12].

**Table 3.** Defectiveness of the insulation of enameled wires in the state of delivery and after mechanical stress

Type of wire	In the form of delivery	Insulation defectiveness $\lambda$ (mm <sup>-1</sup> ) after simulating technological impacts for samples with different elongation, %		
		3	5	7
Type 1*	0,0012	0,0012	0,016	0,118
Type 3	0	0	0	0,0004
Type 2	0	0	0	0
Type 6	0	0	0	0

\*Aluminum conductor.

**Table 4.** Defectiveness of the insulation of enameled wires after mechanical stress and soaking in a solvent

Type of wire	Insulation defectiveness $\lambda$ (mm <sup>-1</sup> ) after mechanical impacts and soaking in a solvent for samples with different relative elongation, %			
	0	3	5	7
Type 1*	0,036	0,0416	0,0524	0,076
Type 3	0	0,00012	0,00028	0,00036
Type 2	0,0016	0,002	0,003	0,0028
Type 6	0	0	0	0,0002

\*Aluminum conductor.

In addition, the formation of defects is influenced by the action of solvents and reactive components of impregnating materials during the impregnation and drying of windings. This can lead to softening and swelling of the enamel, reducing insulation strength.

The research results on the combined effect of mechanical loads and solvents on the defectiveness of the insulation of enameled wires are shown in Table 3. Wire samples with a relative elongation of 3, 5, and 7 % were tested. The winding of wire samples imitating bending was carried out according to [11]. Wire samples were placed in a container with a solvent, loaded into a heating cabinet, and held for 30 minutes; dried and wiped before testing. It can be noted that such complex tests provide a reliable assessment of both the mechanical resistance of enamel insulation to impact loads and the degree of its damage. Only in this case, the exact number of defects is determined.

For example, wire type 1\* showed a very high defectiveness  $\lambda$  after stretching, which indicates a minimum resistance to technological influences. This is typical for wires with an aluminum core since the adhesion of the enamel film to aluminum is

much less than to copper. Therefore, the enamel insulation thins and cracks when stretched, therefore the defectiveness increases. At the same time, the results of standard tests (Fig. 1–3, Table 1) showed that enamel insulation has sufficient abrasion resistance. As a result, an incorrect conclusion can be drawn about the mechanical strength of the insulation of this wire.

For wires of types 2, 3, and 6, good mechanical strength, determined by standard methods, is confirmed by a low defectiveness value.

In recent years, consumers of winding wires have made a new requirement [2–4, 8, 13–17]: the resistance of enamel insulation to corona discharges. This problem is typical for the windings of electric motors operating as part of a frequency-controlled drive. Frequency converters are built based on semiconductor switches with a high switching speed which causes increased electrical loads during operation.

Electrical surges in low-voltage windings lead to electrical discharges on the surface of the insulation, which significantly accelerates its aging and defect formation processes.

Unfortunately, in the domestic technical literature, there is not enough information about any methods and recommendations for determining the resistance of enameled wires to the action of electrical discharges.

To assess the resistance of enamel insulation to surface discharges, a technique has been proposed: holding a wire sample in an environment of electric discharges at high voltage [18]. The tests were carried out in the system of electrodes «wire–shot» (Fig. 4), placed in a high-voltage cell (HVC). The general scheme of the installation for testing is shown in Fig. 5.

A grounded wire sample is placed in a steel shot bath that completely covers the part of the sample to be tested (test length is not less than 125 mm). A high voltage from the test apparatus (AID-90) is applied to the flat metal electrode (from 3,5 to 5,5 kV, depending on the type of wire). The action of a high-strength electric field in the shot leads to appearance of surface discharges, which, acting on the insulation of the wire under test, gradually reduce the electrical insulating properties of the enamel, leading to appearance of defects and, as a result, to its breakdown [18].

The occurrence of surface discharges is possible provided that the maximum strength  $E_{\max}$  exceeds the critical strength  $E_{cr}$  of the electric field in the selected system of electrodes [19].

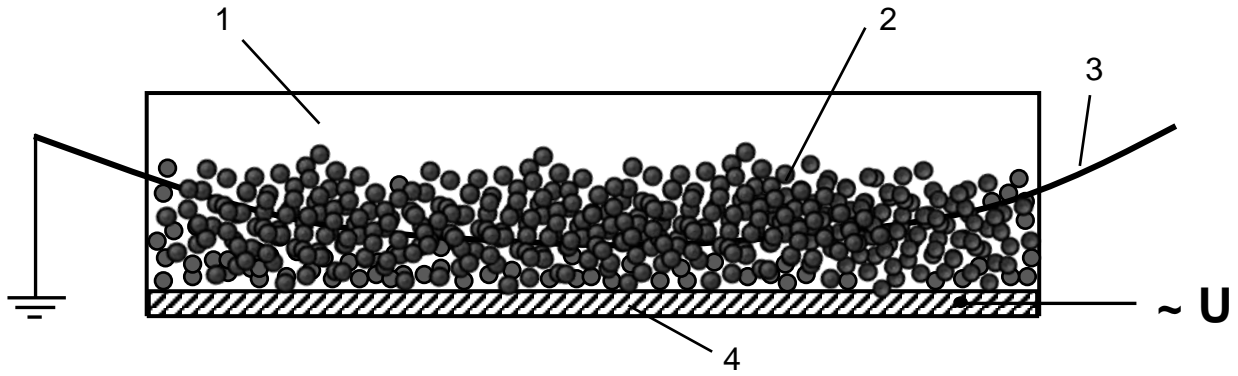

Fig. 4. Device for testing the insulation of enameled wires: 1) bath; 2) steel shot; 3) wire sample; 4) metal electrode

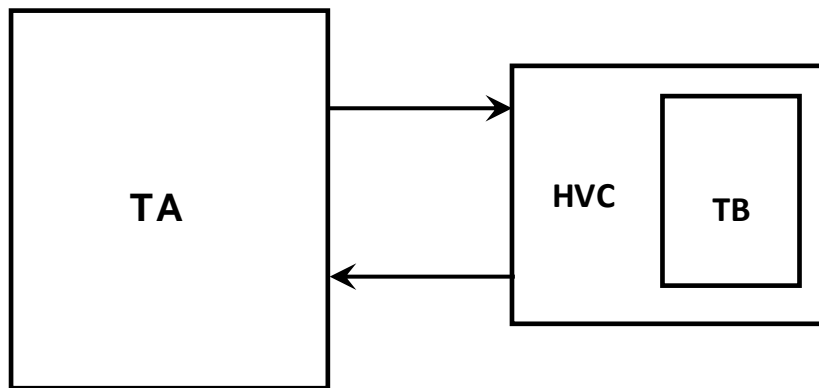

Fig. 5. Block diagram of the installation for determining the resistance of enameled winding wires to surface discharges: TA – test apparatus; HVC – high-voltage cell; TB – test block

The critical electric field strength  $E_{cr}$  can be determined by Formula (1) [20]:

$$E_{cr} = 1,65m\delta \left[ \frac{0,13}{(\delta R)^{0,38}} \right], \text{ V/m}, \quad (1)$$

where  $m=(0,5\div 0,9)$  is the smoothness coefficient;  $\delta=1$  is the relative air density;  $R=1$  mm is the shot radius.

The proposed test conditions in the «wire–shot» electrode system:  $E_{cr} = 1,5 \cdot 10^6$  V/m.

The magnitude of the maximum electric field strength  $E_{max}$  was determined using the COMSOL Multiphysics software package. The results (Fig. 6) showed that at test voltage  $U_{test}=4$  kV, the value  $E_{max}=4,5 \cdot 10^{-6}$  V/m, which exceeds  $E_{cr}$  and indicates the presence of surface discharges during testing of wire samples.

The insulation resistance was evaluated by the time the voltage was applied to the breakdown of the insulation of the tested wire sample.

The result was taken as the arithmetic mean of the time  $t_{br}$  for at least ten samples at a fixed value of the test voltage (Formula (2)):

$$t_{br} = \frac{\sum_{i=1}^n t_{bri}}{n}, \quad (2)$$

where  $\sum_{i=1}^n t_{bri}$  is the sum of the values of time to breakdown, and  $n$  is the number of samples.

Tests were carried out on wires of types 1–6 with a close diameter of  $0,9\div 1,05$  mm. The results of determining the resistance of enameled wires to surface discharges are shown in Table 6.

Table 6. Average time to breakdown  $t_{pr}$  of wire insulation in the «wire–shot» electrode system

Type of wire	Test voltage $U_{test}$ , kV				
	3,5	4	4,5	5	5,5
Type 1*	330	120	50	–	–
Type 2	–	4000	1750	1140	100
Type 3	–	2600	820	330	60
Type 4	–	1700	900	270	75
Type 5	–	920	660	300	100
Type 6	–	5300	2100	1900	450

\*Aluminum conductor.

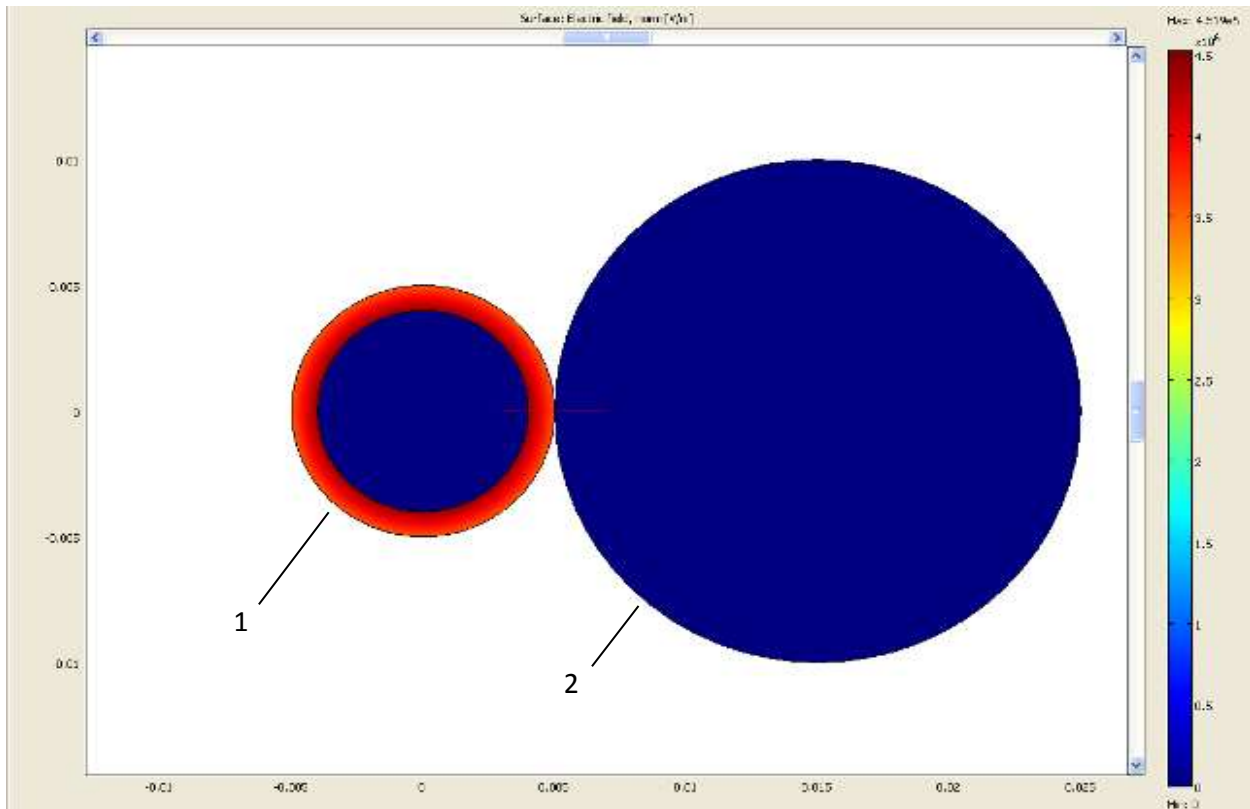

**Fig. 6.** Electric field strength distribution in the «wire-shot» system: 1) enameled wire; 2) fraction

The data obtained clearly demonstrate the varying degrees of resistance of enameled wires to electrical loads (in descending order): type 6, type 2, type 3, type 4, type 5, and type 1\*.

Type 2 and type 6 wire insulation has the highest average time to break down. The difference in resistance to surface discharges of these enameled wires becomes visible at a test voltage level above 5 kV or after preliminary application of mechanical loads on samples (tensile samples, winding on a metal rod with a diameter equal to double the wire diameter) (Table 7) [4].

**Table 7.** Mean time to breakdown  $t_{pr}$  insulation of enameled wires after stretching (relative elongation 5 %)

Type of the wire	Test voltage $U_{test}$ , kV	
	4	4,5
Type 2	1981	1271
Type 6	2691	1714

The results clearly show that under the action of surface discharges, type 6 wire retains its properties at a higher level. The insulation of this wire is a two-layer composition that provides the necessary resistance to the action of electric discharges [17].

Currently, there is no clear information on the justification of the limiting value of defectiveness. The permissible limit of the defect level  $\lambda$  should be

determined, considering the reliability indicators of the inter-turn insulation since the number of defects critically affects the probability of its failure.

In work, according to the method [12], the authors calculated the effect of defectiveness on the probability of failure-free operation of a few inter-turn insulation systems for several dimensions of asynchronous motors of the AIR series (height of the rotation axis 71, 90 and 160 mm). The primary initial data for the calculation are given in [20]. Winding data were taken according to [12]. The coefficients of the defect formation rate equation are chosen considering the insulation systems according to the literature data [12].

The results show that at the level of defectiveness  $\lambda > 0,006 \text{ mm}^{-1}$ , the probability of failure-free operation for all considered options decreases below the maximum permissible level:  $P_{tt} < 0,9$  with an operating time of 20,000 hours [12, 20]. This allows the value of  $\lambda$  equal to  $0,006 \text{ mm}^{-1}$  being taken as the limiting level of defectiveness, the excess of which leads to irreversible decrease in the reliability of the inter-turn insulation and the entire winding.

Thus, the determination of the exact number of defects and insulation resistance to their formation is recommended to be carried out using the criterion Formula (3):

$$\lambda_a = \lambda_s + \lambda_t \leq 0,006 \text{ mm}^{-1}. \quad (3)$$

The value of  $\lambda_a$  can be calculated by determining defectiveness in the electrolyte, which makes it possible to initially detect the presence of defects in low-quality enamel insulation or their subsequent growth in manufacturing windings [12].

If the results of determination of defectiveness showed an excess of  $\lambda > 0,006 \text{ mm}^{-1}$  at any stage of testing (in the state of delivery; after mechanical impacts), it is recommended to choose another batch or brand of wire.

In addition, to meet consumers' requirements regarding the increase in the resistance of the enamel insulation of wires to the action of increased electrical loads, it is proposed to conduct additional tests in the «wire-shot» electrode system.

This test must be carried out for enameled wires used in the motor windings of a frequency-controlled drive based on pulse-width modulation. The criterion for enamel insulation resistance to the action of electrical discharges is the average time to breakdown, determined by Formula (2).

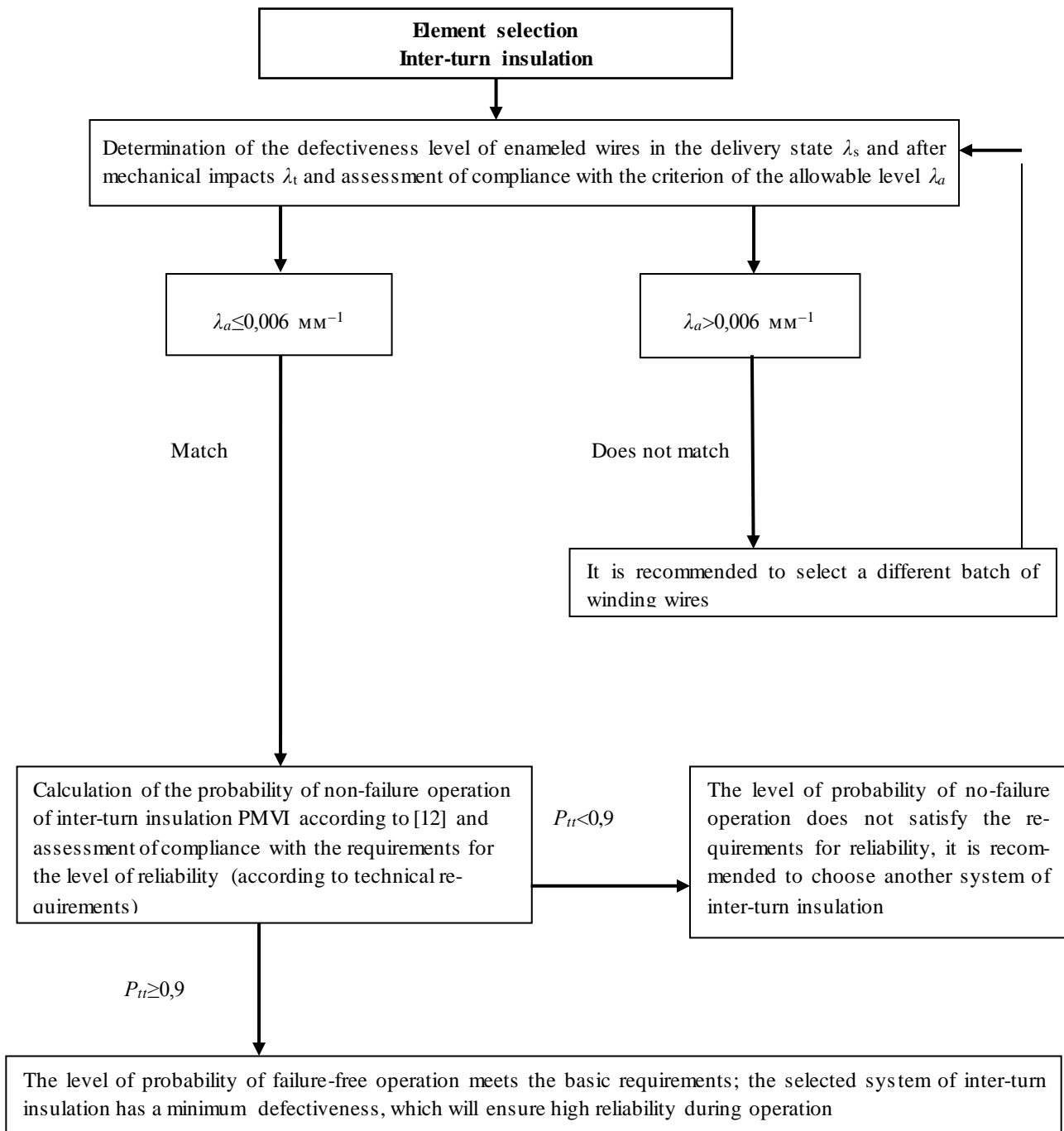

Fig. 7. Flowchart of measures to ensure the minimum defectiveness  $\lambda$  of inter-turn insulation

The interval of change of the test voltage of industrial frequency  $U_{\text{test}}$  can be taken as 4–5,5 kV. The minimum value simultaneously ensures the appearance of surface discharges on the surface of the wire, and the maximum value is not enough for the break-down of intact, defect-free enamel insulation.

As a standard, it is proposed to take the average time to break down the enameled wire of corona-resistant type 6. This is the only brand of wire produced in the Russian Federation with insulation resistant to electrical loads typical for variable frequency drive systems [12]. As studies have shown for this wire, the average time to breakdown at  $U_{\text{test}}=4$  kV was  $t_p \geq 85$  minutes, at  $U_{\text{test}}=5,5$  kV it was  $t_p \geq 7$  minutes.

The general sequence of measures to reduce the defectiveness of inter-turn insulation during manufacture and operation is presented in the form of a flowchart in Fig. 7.

## Conclusion

The results of the conducted research allow us to note the following:

1. The existing methods assess the enamel insulation quality at the incoming inspection. They do

not always allow identifying enameled wires with low insulation resistance to forming defects. The evaluation criteria used (breakdown voltage of the enameled wire insulation  $U_{\text{br}}$  and the number of double strokes of the needle N of the steel needle before the insulation is destroyed) are uninformative. They do not allow a reliable assessment of the properties of the enamel insulation.

2. An effective characteristic that reflects the natural resistance of insulation to technological influences is defectiveness; complex tests of samples to determine the defectiveness  $\lambda$  of enamel insulation provide a comprehensive qualitative and quantitative assessment of its resistance to the appearance of defects.
3. Tests in the «wire-shot» electrode system (Patent for invention no. 2491565 dated 08/27/13) allow a qualitative assessment of the enamel insulation resistance to defect formation under the action of surface discharges.
4. The probability of non-failure operation of the inter-turn insulation  $P_{\text{ti}} \geq 0,9$  with an operating time of 20,000 hours is provided with an enamel insulation defect of no more than  $0,006 \text{ mm}^{-1}$ .

## References

- [1] Grubic S., Aller J.M., Lu B., Habetler T.G. A Survey on Testing and Monitoring Methods for Stator Insulation Systems of Low-Voltage Induction Machines Focusing on Turn Insulation Problems. *IEEE Transactions on Industrial Electronics*, 2008, vol. 55, no. 12, pp. 4127–4136. DOI 10.1109/TIE.2008.2004665
- [2] Kaufhold M., Aninger H., Berth M., Speck J., Eberhardt M. Electrical stress and failure mechanism of the winding insulation in PWM-inverter-fed low-voltage induction motors. *IEEE Transactions on Industrial Electronics*, 2000, vol. 47, no. 2, pp. 396–402. DOI 10.1109/41.836355
- [3] Fenger M., Campbell S.R., Pedersen J. Motor winding problems caused by inverter drives. *IEEE Industry Applications Magazine*, 2003, vol. 9, no. 4, pp. 22–31. DOI 10.1109/MIA.2003.1206913
- [4] Leonov A.P., Redko V.V., Soldatenko E.Yu. Estimation of winding insulation resistance to the corona discharges. *IOP Conference Series: Materials Science and Engineering*, 2014, vol. 66, issue 1, article id. 012004 (2014). DOI: 10.1088/1757-899X/66/1/012004
- [5] Fenger M., Campbell S.R., Pedersen J. Motor winding problems caused by inverter drives. *IEEE Industry Applications Magazine*, 2003, vol. 9, no. 4, pp. 22–31. DOI: 10.1109/MIA.2003.1206913
- [6] Bogh D., Coffee J., Stone G., Custodio J. Partial-discharge-inception testing on low-voltage motors. *IEEE Transactions on Industry Applications*, 2006, vol. 42, no. 1, pp. 148–154. DOI: 10.1109/TIA.2005.861369
- [7] Andrianov A.V., Andrianov V.K., Bykov E.V. O statistike tochechnykh povrezhdeniy obmotochnykh provodov i vitkovykh zamykaniyakh obmotok [On the statistics of point damage to wires and winding windings]. *Cables and wires*, 2013, no. 5 (342), pp. 28–31.
- [8] Zelenetsky Yu.A., Kobelev A.S. Povysheniye energoeffektivnosti asinkhronnykh elektrodvigatelay putem primeneniya emalirovannykh provodov, izgotovlennykh po sovremennoy tekhnologii [Improving the energy efficiency of asynchronous electric motors by using enameled wires made using modern technology]. *Cables and wires*, 2015, no. 4 (353), pp. 15–20.
- [9] *Provoda emalirovannyye kruglye. Metody ispytaniya mekhanicheskoy prochnosti izolyatsii na istiraniye. GOST 14340.10-69* [Enameled round wires. Methods for testing the mechanical strength of insulation for abrasion. SS 14340.10-69]. Moscow, IPK standards publishing house, 1999. 7 p.
- [10] Winding wires – test methods. P. 3: Mechanical properties. IEC 60851-3:2002. 2002.
- [11] Winding wires – test methods. P. 5: Electrical properties. IEC 60851-5:2008. Ed. 4.0, 2008.
- [12] Goldberg O.D., Khelemskaya S.P. *Nadezhnost elektricheskikh mashin* [Reliability of electrical machines]. Moscow, Akademiya Publ., 2010. 288 p.
- [13] Ghassemi M. Accelerated insulation aging due to fast, repetitive voltages: A review identifying challenges and future research needs. *IEEE Transactions on Dielectrics and Electrical Insulation*, 2019, vol. 26, no. 5, pp. 1558–1568. DOI: 10.1109/TDEI.2019.008176.



- [14] Guide for the statistical analysis of electrical insulation breakdown data. IEC 62539:2007. Ed. 1.0. 2007.
- [15] Lahoud N., Faucher J., Malec D., Maussion P. Electrical aging of the insulation of low voltage machines: model definition and test with the design of experiments. *IEEE Transactions on Industrial Electronics*, 2013, vol. 60, pp. 4147–4155. DOI: 10.1109/TIE.2013.2245615
- [16] Belassel M.-T. Vliyaniye tipa obmotki na perenapryazheniya v asinkhronnykh dvigatelyakh, rabotayushchikh ot chastotnykh preobrazovateley [Influence of winding type on overvoltages in asynchronous motors operating from frequency converters]. *Electrical engineering*, 2013, no. 8, pp. 30–33.
- [17] Andrianov V.K., Peshkov I.B., Meshchanov G.I., Burakov O.B. *Koronastoykiy obmotochnyy provod* [Corona-resistant winding wire]. Patent RF 80267, 2009.
- [18] Leonov A.P., Korobtsov A.A., Supueva A.S. *Sposob opredeleniya stoykosti izolyatsii emalirovannykh provodov k poverkhnostnym razryadam* [A method for determining the resistance of enameled wire insulation to surface discharges]. Patent RF 2491565, 2013.
- [19] Merkulov V.I. *Matematicheskoye modelirovaniye v elektrozolyatsionnykh konstruktsiyakh*. [Mathematical modeling in electrical insulating structures]. Tomsk, TPU Publ. house, 2001. 152 p.
- [20] Petrikov L.V., Kornachenko G.N. *Asinkhronnyye dvigateli: Obmotochnyye dannyye. Remont. Modernizatsiya. Spravochnik* [Induction motors: Winding data. Repair. Modernization. Directory]. Moscow, Energoatomizdat Publ., 2000. 496 p.

*Received: February 14, 2022*