

## DYNAMIC QUANTUM VACUUM AND RELATIVITY

Davide Fiscaletti<sup>1\*</sup>, Amrit Sorli<sup>2</sup>

<sup>1</sup> SpaceLife Institute, Via Roncaglia, 35 – 61047 San Lorenzo in Campo (PU), Italy

<sup>2</sup> Foundations of Physics Institute, Idrija, Slovenia

### ABSTRACT

A model of a three-dimensional dynamic quantum vacuum with variable energy density is proposed. In this model, time we measure with clocks is only a mathematical parameter of changes running in quantum vacuum. Mass and gravity are carried by the variable energy density of quantum vacuum. Each elementary particle is a structure of quantum vacuum and diminishes the quantum vacuum energy density. Symmetry “particle – diminished energy density of quantum vacuum” is the fundamental symmetry of the universe which gives origin to the inertial and gravitational mass. Special relativity’s Sagnac effect in GPS system and important predictions of general relativity such as precessions of the planets, the Shapiro time delay of light signals in a gravitational field and the geodetic and frame-dragging effects recently tested by Gravity Probe B, have origin in the dynamics of the quantum vacuum which rotates with the earth.

**Keywords:** energy density of quantum vacuum, Sagnac effect, relativity, dark energy, Mercury precession.

**PACS numbers:** 04.; 04.20-q ; 04.50.Kd; 04.60.-m.

---

\* Corresponding author. E-mail address: spacelife.institute@gmail.com

## 1. INTRODUCTION

The idea of 19<sup>th</sup> century physics that space is filled with “ether” did not get experimental proof in order to remain a valid concept of today physics. The concept of ether was expelled from physics in the light of the null result of Michelson-Morley experiment, which led to the prevailing opinion, during the 20<sup>th</sup> century, that photons can move in an empty space which has no physical origin. However, the idea that material objects can exist in some empty space has created some unsolvable problems regarding the description of Sagnac effect in Global Positioning System (GPS), as well as the interpretation of mass and gravity.

On the other hand, 20<sup>th</sup> century theoretical physics brought the idea of a quantum vacuum as a fundamental medium subtending the observable forms of matter, energy and space-time. As a consequence of quantum field theories and cosmology, the physical vacuum can be regarded as a unified system governing the processes taking place in the micro- and the macroworld, which manifests itself on all space-time scales. The real particles such as electrons, positrons, photons, hadrons etc. as well as all macroscopic bodies are quantum wave-like excitations of this medium endowed with certain quantum numbers ensuring their relative stability. According to the Standard Model, the physical vacuum can be characterized by a total vacuum energy density which has at least the following three contributions: the fluctuations characterizing the zero-point field, the fluctuations characterizing the quantum chromodynamic level of sub-nuclear physics, and the fluctuations linked with the Higgs field. Moreover, one can speculate that there are also contributions from possible existing sources outside the Standard Model (for instance, grand unification theories, string theories, etc...). The missing point inside the physics of the 20<sup>th</sup> century is that a region of universal space which theoretically is void of all fields, elementary particles and massive objects still exists on its own and so must have some concrete physical origin. The so-called “empty space” is a type of energy that is “full” of itself, has its independent physical existence. We do not suggest the necessity to “resurrect” the idea of ether here, we just point out that the concept of “empty space” deprived of physical properties represents an a-priori accepted concept in the physics of the 20<sup>th</sup> century.

The existence of a fundamental medium, able to reproduce the dynamical features of a concrete universal space and, in reality, constituting the deepest essence of universal space itself, is an ontological necessity in order to obtain general relativity as the mathematical description, in the low energy – long wavelength limit, of the space elementary structure and to create the bridge between quantum mechanics and general relativity. This could finally lead to a consistent theory of quantum gravity, in which the quantization will be made on a field function describing the quantum vacuum and not on collective macroscopic variables constructed from it, as in all the proposed and commonly accepted alternative theories of quantum gravity.

As regards the role of the different contributions to the vacuum energy density, Timashev examined the possibility of considering the physical vacuum as a unified

system governing the processes taking place in microphysics and macrophysics [1]. We have explored recently this possibility by introducing, on the basis of the Planckian metric emerging, for example, from loop quantum gravity [2, 3, 4], a model of a three-dimensional (3D) dynamic quantum vacuum (DQV) in which general relativity emerges as the hydrodynamic limit of some underlying theory of a more fundamental microscopic 3D quantum vacuum condensate where each elementary particle is determined by elementary reduction-state (**RS**) processes of creation/annihilation of quanta (more precisely, of virtual pairs particles-antiparticles) corresponding to an opportune change of the quantum vacuum energy density [5, 6]. In this approach, which can be called as “model of the 3D DQV”, the variable energy density of DQV is the fundamental energy which gives origin to the different physical entities existing in the universe. The DQV energy density, as fundamental energy of the universe, cannot be created and cannot be destroyed. All different particles are different “structures” of DQV. A given particle diminishes energy density of DQV. Symmetry between a given particle or massive body as a “structured DQV” and the region of diminished energy density around is a fundamental symmetry of the universe which generates inertial and gravitational mass in microphysics and in macrophysics. In this model, time is a fundamental quantity of the universe which has only a mathematical existence, namely numerical order of changes. The curvature of space-time characteristic of general relativity emerges as a mathematical value of a more fundamental actual energy density of quantum vacuum. The fluctuations of the quantum vacuum energy density generate a curvature of space-time similar to the curvature produced by a “dark energy” density [6]. In other words, one can say that, in this model, dark energy is energy of quantum vacuum itself. It is not that some unknown energy exists in universal space. Energy of universal space which originates from fluctuations of quantum vacuum is dark energy.

According to the view suggested in this paper, a three-dimensional DQV (characterized by a symmetry between particles and variations of DQV energy density) can be considered as the fundamental arena of the universe. In particular, here we will show that both special relativity’s Sagnac effect and significant general relativistic predictions (such as precession of the planets, the Shapiro time delay of light signals in a gravitational field, the geodetic and frame-dragging effect recently tested by Gravity Probe B) have origin in a “dragging” effect of DQV with the rotating earth, which allows us to obtain results in complete agreement with those of Einstein. A friction acts on bodies moving in the DQV, which causes frame dragging effect, which was studied, for example, by Francis Everitt group (see [7] for a review of this research).

In GPS relativity of clocks rate (associated to a special relativistic effect and a general relativistic effect) also has origin in variable energy density of DQV. Less dense is DQV energy, slower is rate of clocks, namely slower is the speed of material changes. Relativistic mass of a given particle is also a result of additional lower energy density of DVQ and additional absorption of quantum vacuum energy due to its high velocity. In this model velocity of light all over the universe is

constant with a minimal variation which depends of the variable energy density of DQV (in agreement with Shapiro effect).

A given material object, stellar object or particle cannot be examined separately from the region of diminished quantum vacuum energy density which is moving with it. An extended region of diminished energy density of quantum vacuum around the Earth is moving with the Earth. In this picture, the null result of Michelson-Morley experiment is determined by the motion effect of the region of diminished quantum vacuum energy density around the Earth with the Earth.

According to Sato's recent research GPS system functions because Earth rotates in the fixed ether. Sato showed that the complete ether-dragging hypothesis is compatible with the Michelson-Morley experiment in a picture where the speed of light  $c$  is not a fixed constant in each inertial reference frame [8]. The hypothesis of ether-dragging was derived from the proposal by Maxwell that the Maxwell equation and wave equation are satisfied in the stationary coordinate system, i.e., the stationary ether. Maxwell predicted an ether-wind; however, GPS experiments showed that the ether-wind was not observed at least up to 20,000 km from the ground level. Today, the GPS experiments show that if there is ether-dragging, it will be observed as an ether-wind more than 20,000 km from the ground level. Moreover, the ether is not only dragged but also modified by gravity. The values of the permittivity and permeability of the free space change in order to satisfy the effect of the gravitational field on the time dilation, and these modifications determine a decrease of the speed of light. In our model DQV is the medium of light propagation, which Sato names "ether". We propose Michelson-Morley experiment will not give null result on the satellite which is more than 20,000 km distant from the Earth (see figure 1).

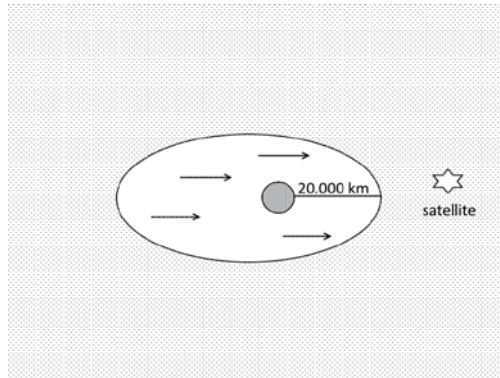

**Figure 1:** Region of diminished energy density of DQV is moving with the Earth.

In special relativity light has a constant velocity in all inertial systems regardless their motion because light is a vibration (excitation) of DQV and all inertial systems move in DQV. Frequency of light from a given source is variable in inertial systems with different velocity because of Doppler effect (see figure 2):

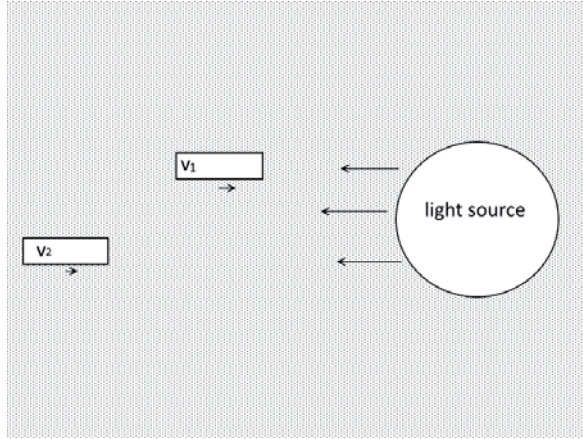

$$c_1 = c_2$$

$$v_1 \succ v_2 \rightarrow \gamma_1 \succ \gamma_2$$

**Figure 2:** Constancy of  $c$  and variability of light frequency in special relativity.

This paper is structured in the following manner. In chapter 2 we will review the interpretation of mass and gravity in the 3D quantum vacuum model proposed by the authors in the papers [5, 6], focusing the attention on the equivalence between the fluctuations of the quantum vacuum energy density and the curvature produced by the dark energy density and, then, we will introduce the concept of the “dragging” phenomenon of a region of 3D quantum vacuum determined by the changes of its energy density. In chapter 3 we will analyse the Sagnac effect in the context of the 3D quantum vacuum model. In chapter 4 we will explore the role of the “dragging” effect of the quantum vacuum as regards precessions of the planets. In chapter 5 we will analyse the re-reading provided by the 3D quantum vacuum model of the Shapiro time delay of light signals in a gravitational field, as well as of the geodetic and frame-dragging effects recently tested by Gravity Probe B. In chapter 6 we will introduce a possible link between quantum vacuum energy density and relative velocity of clocks. Finally, in chapter 7 we will make some cosmological considerations in the dynamic quantum vacuum model.

## 2. INERTIAL MASS, GRAVITATIONAL MASS, ENERGY DENSITY OF QUANTUM VACUUM AND DARK ENERGY

In a given physical system or region of space, energy has a tendency for homogeneous distribution. In a given volume  $V$  of universal space the total sum of the different forms of energies (due to the different physical interactions and fields) tends to be constant [9]. Quantum vacuum, intended as a unified system governing the processes taking place in the micro- and the macroworld, is dynamic in the sense

that the presence of a given stellar object or elementary particle (or interaction) reduces the amount of the quantum vacuum energy.

In the absence of elementary particles, atoms and massive objects, energy density of quantum vacuum is defined by the following relation:

$$\rho_{pE} = \frac{m_p \cdot c^2}{l_p^3} \quad (1)$$

where  $m_p$  is Planck mass, and  $l_p$  is Planck length. The quantity (1) is the maximum value of the quantum vacuum energy density and physically corresponds to the total average volumetric energy density, owed to all the frequency modes possible within the visible size of the universe, expressed by

$$\rho_{pE} = \sqrt{\frac{c^{14}}{\hbar^2 G^4}} \approx 4,641266 \cdot 10^{113} J/m^3 \cong 10^{97} Kg/m^3. \quad (2)$$

The DQV energy density (1) identifies a 3D Euclidean space as a preferred fundamental arena, which is quantitatively defined by Galilean transformations for the three spatial dimensions

$$\begin{aligned} X' &= X - v \cdot \tau \\ Y' &= Y \\ Z' &= Z \end{aligned} \quad (3)$$

and Selleri's transformation

$$\tau' = \sqrt{1 - \frac{v^2}{c^2}} \cdot \tau. \quad (4)$$

for the rate of clocks (where  $v$  is the velocity of the moving observer O' of the inertial frame o' measured by the stationary observer O and  $\tau$  is the proper time of the observer O of the rest frame o, namely the speed of clock of the observer O). The clocks' running as well as the other relativistic effects are influenced by the motion relative to the rest frame of the Euclidean space associated with the quantum vacuum energy density (1) [10].

The quantum vacuum energy density (2) is usually considered as the origin of the dark energy and thus of a cosmological constant, if the dark energy is supposed to be owed to an interplay between quantum mechanics and gravity. However, the observations are compatible with a dark energy density

$$\rho_{DE} \cong 10^{-26} Kg/m^3 \quad (5)$$

and thus equations (2) and (5) give rise to the so-called “cosmological constant problem” because the dark energy (5) is 123 orders of magnitude larger than (3). In order to solve this problem, Santos recently proposed an explanation for the actual value (4) which invokes the fluctuations of the quantum vacuum [11]. In Santos’ approach the dark energy density  $\rho_{DE}$  is the effect of the quantum vacuum fluctuations on the curvature of space-time according to equation

$$\rho_{DE} \cong 70G \int_0^{\infty} C(s) s ds \quad (6)$$

which states that the possible value of the “dark energy” density is the product of Newton’s gravitational constant times the integral of the two-point correlation function of the vacuum fluctuations defined by

$$C(|\vec{r}_1 - \vec{r}_2|) = \frac{1}{2} \langle vac | \hat{\rho}(\vec{r}_1, t) \hat{\rho}(\vec{r}_2, t) + \hat{\rho}(\vec{r}_2, t) \hat{\rho}(\vec{r}_1, t) | vac \rangle, \quad (7)$$

$\hat{\rho}$  being an energy density operator such that its vacuum expectation is zero while the vacuum expectation of the square of it is not zero. The relations between the metric coefficients and the matter stress-energy tensor are non-linear and, as a consequence, the expectation of the metric turns out to be not the same as the metric of the expectation of the matter tensor and the difference between these two quantities gives rise to a contribution of the vacuum fluctuations mimicking the effect of Einstein’s cosmological constant. In Santos’ approach, in analogy with a suggestion of Zeldovich [12], the observed value of the dark energy density (5) may also be reproduced by proposing that an elementary particle with frequency  $\omega = Gm^3 c / \hbar^2$  determines a gravitational energy density due to dark matter given by

$$\rho_{DE} c^2 \cong \hbar \omega / r_c^3 \quad (8)$$

where  $r_c = \hbar / mc$  is its Compton’s radius.

Moreover, in the picture of Rueda’s and Haisch’s interpretation of the inertial mass as an effect of the electromagnetic quantum vacuum [13], the presence of a particle with a volume  $V_0$  expels from the vacuum energy within this volume exactly the same amount of energy as is the particle’s internal energy (equivalent to its rest mass) according to relation

$$m_0 = \frac{V_0}{c^2} \int \eta(\omega) \frac{\hbar \omega^3}{2\pi^2 c^3} d\omega \quad (9)$$

where the dimensionless parameter  $\eta(\omega)$  represents the frequency dependent part of the scattering of the energy flux (namely the gauge factor).

Taking account of Santos’ results and of Rueda’s and Haisch’s results, one can consider that each elementary particle is associated with fluctuations of the quantum vacuum which determine a diminishing of the quantum vacuum energy density. In



our model, the quantum vacuum energy density (1) can be considered as the ground state of the same physical flat-space background. The appearance of material objects and subatomic particles correspond to changes of the quantum vacuum energy density and thus can be considered as the excited states of the same DQV. In other words, energy of matter can be seen as a structured energy of DQV. Every particle is made out of DQV energy and thus it is not a different entity from quantum vacuum energy. Every particle can be considered as an excited state of the same DQV characterized by a lower energy density than the Planck energy density (1): each excited state of the DQV is defined by a diminished energy density which corresponds exactly to the energy of the particle under consideration. In this sense, matter cannot be seen as an isolated element in universal space: particles and the region of diminished energy density of quantum vacuum are inseparable.

Each material object endowed with a mass  $m$  is produced by a change of the DQV energy density on the basis of equation

$$m = \frac{V \cdot \Delta\rho_{qvE}}{c^2}, \quad (10)$$

where

$$\Delta\rho_{qvE} = \rho_{pE} - \rho_{qvE}, \quad (11)$$

$$\rho_{qvE} = \rho_{pE} - \frac{m \cdot c^2}{V} = \rho_{pE} - \frac{3m \cdot c^2}{4\pi \cdot r^3}, \quad (12)$$

where  $m$  is the mass of the object,  $V$  is its volume and  $r$  is the radius of the material object (interpreted as a sphere).

Equation (12) expresses DQV energy density in the centre of the material object under consideration. On the basis of equation (12), DQV energy density constitutes an ontologically primary physical reality with respect to mass.

In this picture, the appearance of baryonic matter derives from an opportune excited state of the 3D quantum vacuum defined by an opportune change of the quantum vacuum energy density and corresponding to specific reduction-state (**RS**) processes of creation/annihilation of quanta (analogous to Chiatti's and Licata's transactions [14, 15]). The excited state of the quantum vacuum corresponding to the appearance of a material particle of mass  $m$  is defined (in the centre of that particle) by the energy density (12) (and by the change of the energy density (11), with respect to the ground state) and its evolution is determined by opportune **RS** processes of creation/annihilation of quanta described by a wave function at two components satisfying a time-symmetric extension of the Klein-Gordon quantum relativistic equation



$$\begin{pmatrix} H & 0 \\ 0 & -H \end{pmatrix} C = 0, \quad (13)$$

where  $H = \left( -\hbar^2 \partial^\mu \partial_\mu + \frac{V^2}{c^2} (\Delta \rho_{qvE})^2 \right)$ . Equation (13) corresponds to the following equations

$$\left( -\hbar^2 \partial^\mu \partial_\mu + \frac{V^2}{c^2} (\Delta \rho_{qvE})^2 \right) \psi_{Q,i}(x) = 0 \quad (14)$$

for creation events and

$$\left( \hbar^2 \partial^\mu \partial_\mu - \frac{V^2}{c^2} (\Delta \rho_{qvE})^2 \right) \phi_{Q,i}(x) = 0 \quad (15)$$

for destruction events.

In this way, it is considered here the possibility that relations (10)-(12) are valid both in macrophysics and in microphysics. Equations (10)-(12) describe baryonic matter both in macrophysics and in microphysics.

On the other hand, in a series of recent papers [16-19], Sbitnev introduced the perspective to describe the physical vacuum as a super-fluid medium, containing pairs of particles-antiparticles which make up a Bose-Einstein condensate, characterized by relativistic hydrodynamical equations which lead to the emergence of quantum equations (the Klein-Gordon equation and, in the non-relativistic limit, the Schrödinger equation) and provide a description of the motion of spiral galaxies. Taking account of Sbitnev's results, here we can therefore assume that, in the presence of ordinary baryonic matter, the 3D quantum vacuum physically acts as a superfluid medium, which consists of an enormous amount of **RS** processes of creation/annihilation of particles-antiparticles with opposite orientations of spins (namely that these pairs possess zero spin, constitute an organized Bose ensemble, such as for example the case of the superfluid helium [20]). In this way, the 3D quantum vacuum can be characterized by the following Einstein energy-momentum tensor

$$T^{\mu\nu} = (\varepsilon + p) u^\mu u^\nu + p \eta^{\mu\nu}. \quad (16)$$

In equation (16)  $\varepsilon$  and  $p$  are functions per unit volume expressed in units of pressure and the metric tensor  $\eta^{\mu\nu}$  has the spacelike signature  $(-, +, +, +)$ . From the energy-momentum tensor (16), one obtains the following conservation law

$$\partial_\mu (V T^{\mu\nu} / n) = 0, \quad (17)$$

where  $n$  is the number of the **RS** processes of virtual sub-particles characterizing the vacuum medium.

Now, by following the philosophy that underlines Sbitnev's hydrodynamic picture provided in [19], from equations (16)-(17) one obtains the first Fick's law in the relativistic limit in the form

$$j_{\mu} = -\frac{D}{c^2} \partial_{\mu} (\Delta \rho_{qvE}), \quad (18)$$

where  $D$  is a diffusion coefficient having the dimension of  $length^2 / time$ . On the basis of relation (18) the diffusion flux vector can be seen as a result of scattering of the sub-particles of the **RS** processes characterizing the vacuum on each other (and, in particular, turns out to be proportional to the negative value of the gradient of the fluctuations of the quantum vacuum energy density). As a consequence of the motion of the virtual particles corresponding to the elementary fluctuations of the quantum vacuum energy density, space-time is filled with virtual radiation with frequency  $\omega = \frac{c^2}{D}$ . Here, the diffusion coefficient associated with the scattering of the sub-particles of the **RS** processes characterizing the vacuum in a given volume  $V$  can be expressed as

$$D = \frac{\hbar c^2 n}{2\Delta \rho_{qvE} V} \quad (19)$$

and thus the frequency of the virtual radiation produced by the evolution of the **RS** processes is

$$\omega = \frac{2\Delta \rho_{qvE} V}{\hbar n}. \quad (20)$$

In the light of equations (19)-(20), we can say that each elementary fluctuation of the DQV energy density in a given volume produces an oscillation of the vacuum at a peculiar frequency. This means that each material object given by mass (10) corresponds to oscillations of the vacuum given by equation (20).

The total effect of the motion of the virtual particles produced by the amount of **RS** processes characterizing a given region – in correspondence to changes of the quantum vacuum energy density – is to generate a dragging, pushing effect of the 3D quantum vacuum. In particular, one may describe the pushing effect of a region of volume  $V$  of the DQV in a given point at a distance  $R$  from the centre of that volume by defining a velocity of the 3D DQV on the basis of equation

$$v_{qv} = \frac{2\Delta \rho_{qvE} V}{\hbar n} R. \quad (21)$$

The DQV velocity (21) is defined with respect to the special rest frame of the Euclidean space associated with the quantum vacuum energy density (2). In other words, the rest frame corresponding to the Planck energy density is a special frame in which the DQV velocity (21) is zero, all material objects (and thus all variations of the energy density of DQV) correspond to regions of the DQV endowed with a velocity (21) with respect to this special frame.

Going away from the centre of a given material object energy density of quantum vacuum increases according to the following formalism:

$$\rho_{qvE} = \rho_{pE} - \frac{3m \cdot c^2}{4\pi(r+d)^3}, \quad (22)$$

where  $m$  is the mass of the material object,  $r$  is radius of the material object and  $d$  is the distance from the centre of the material object to a given point T (see figure 3). When  $d = 0$ , one gets energy density of QDV in the centre. When  $d = r$ , one gets energy density of DQV on the surface of the stellar object. When  $d \rightarrow \infty$ , one gets energy density of QDV in intergalactic empty space far away from stellar objects.

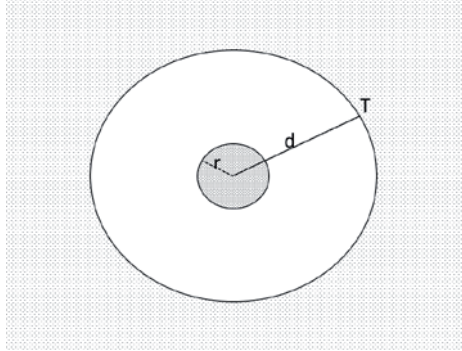

**Figure 3:** Density of DQV in the centre, on the surface and distant from a stellar object.

Inside the Schwarzschild radius

$$r_s = \frac{2Gm}{c^2}, \quad (23)$$

where  $G$  is the gravitational constant and  $m$  is the mass of a stellar object, the energy density of quantum vacuum is at its minimum and constant. Combining equations (12) and (23), we get the following expression for the energy density of quantum vacuum inside Schwarzschild radius:

$$\rho_{qvE} = \rho_{pE} - \frac{3c^8}{32\pi G^3 m^2}. \quad (24)$$

In black holes energy density of quantum vacuum is at its minimum and under its value which is required for stability of elementary particles. Each particle is undividedly related to its region of diminished energy density of DQV. Inside Schwarzschild radius low energy density of quantum vacuum does not provide a necessary quantum vacuum “background” for stability of elementary particles and stability of atoms. That is why inside Schwarzschild radius matter transforms back into electromagnetic energy and this back into energy of quantum vacuum.

On the basis of equations (10), (11), (12), (22) and (24), only a material particle can diminish energy density of quantum vacuum exactly accordingly to its mass/energy. Energy, mass and gravity have the same origin in diminished energy density of DQV. This is expressed in the following equation:

$$E = m \cdot c^2 = \Delta E_{qv} = (\rho_{PE} - \rho_{qvE}) \cdot V. \quad (25)$$

According to equation (25), energy  $E$  of a given particle is made out of quantum vacuum energy  $\Delta E_{qv}$  which diminishes Planck energy density  $\rho_{PE}$  of quantum vacuum in the centre of this particle respectively to amount of its energy  $E$ . Gravitational mass and inertial mass have the same origin. Moreover, energy of relativistic particle in relation with relativistic mass and diminished energy density of DQV can be expressed as:

$$E = \lambda \cdot m \cdot c^2 = \Delta E_{qv}, \quad (26)$$

where  $\gamma$  is the Lorentz factor.

In outer intergalactic space energy density of DQV is at its maximum. Energy of quantum vacuum is forming in electromagnetic waves, called “cosmic radiation” [21] and this further in elementary particles. This circulation of energy in the universe is in permanent dynamic equilibrium. In this picture, universe is not a created system and will not have an end. It is an utter misunderstanding to compare universe and life with man-made machines which are ruled by second law of thermodynamics. Energy of DQV is not created and cannot be destroyed.

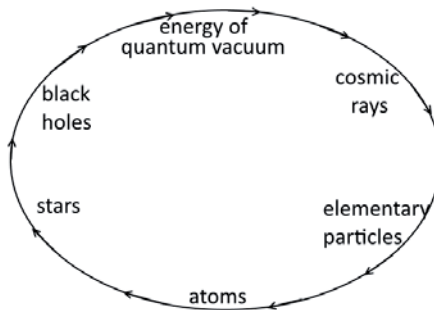

**Figure 4:** Permanent circulation of energy in the universe.

The presence of a material object diminishes the energy density of quantum vacuum. Energy density of quantum vacuum is increasing with the increasing of the distance from a given material object. The higher energy density of quantum vacuum around is pushing towards lower energy density and this pressure is the origin of the inertial and gravitational mass and their equality (see figure 5).

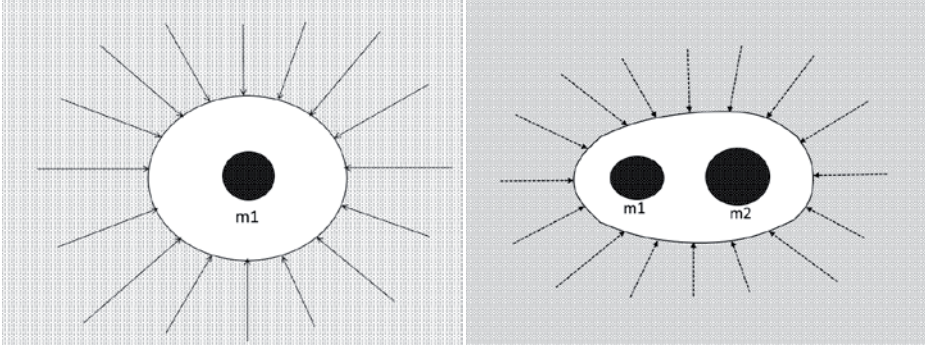

**Figure 5:** Presence of a given material object diminishes energy density of quantum vacuum and this generates inertial mass and gravitational mass.

The presence of two or several material objects, namely elementary particles, atoms, massive objects or stellar objects diminishes the energy density of quantum vacuum thus generating gravitational mass and gravity. Gravity is pushing from the outer higher energy density of quantum vacuum around a given material object towards the lower energy density of quantum vacuum around a given material object.

The changes and fluctuations of the quantum vacuum energy density determine a curvature of space-time similar to the curvature produced by a “dark energy” density, through a quantized metric characterizing the underlying microscopic geometry of the 3D quantum vacuum [6]. In order to illustrate in detail this point, let us remember that, in the model proposed by Santos in [11], the quantum vacuum fluctuations give rise to a curvature of space-time similar to the curvature produced by a “dark energy” density by invoking, in the picture of the Friedmann equations

$$\left[\frac{\dot{a}}{a}\right]^2 = \frac{8\pi G}{3}(\rho_{mat} + \rho_{DE}), \quad \frac{\ddot{a}}{a} = \frac{8\pi G}{3}\left(\frac{1}{2}\rho_{mat}t + \rho_{DE}\right), \quad (27)$$

a quantum metric of the form

$$d\hat{s}^2 = \hat{g}_{\mu\nu} dx^\mu dx^\nu, \quad (28)$$

where the quantum coefficients (in polar coordinates) are

$$\hat{g}_{00} = -1 + \hat{h}_{00}, \quad \hat{g}_{11} = 1 + \hat{h}_{11}, \quad \hat{g}_{22} = r^2(1 + \hat{h}_{22}), \quad \hat{g}_{33} = r^2 \sin^2 \vartheta(1 + \hat{h}_{33}),$$

$$\hat{g}_{\mu\nu} = \hat{h}_{\mu\nu} \text{ for } \mu \neq \nu, \quad (29)$$

where

$$\begin{aligned} \langle \hat{h}_{\mu\nu} \rangle &= 0 \text{ except } \langle \hat{h}_{00} \rangle = \frac{8\pi G}{3} (\rho_{mat} + \rho_{DE}) r^2 \text{ and} \\ \langle \hat{h}_{11} \rangle &= \frac{8\pi G}{3} \left( \rho_{DE} - \frac{1}{2} \rho_{mat} \right) r^2. \end{aligned} \quad (30)$$

In equations (30),  $\langle \hat{h}_{\mu\nu} \rangle$  stands for  $\langle \Psi | \hat{h}_{\mu\nu} | \Psi \rangle$ ,  $\rho_{DE}$  is the dark energy density (4),  $\rho_{mat}$  is the matter density,  $\Psi$  is the quantum state of the universe for which the expectation of the stress-energy tensor operator of the quantum fields satisfies equations

$$\langle \Psi | \hat{T}_4^4 | \Psi \rangle = \frac{\Delta \rho_{qvE}}{c^2}; \quad \langle \Psi | \hat{T}_\mu^\nu | \Psi \rangle \approx 0 \text{ for } \mu\nu \neq 00 \quad (31)$$

in order to obtain the correct Friedmann-Robertson-Walker metric.

Now, in our approach of the 3D DQV whose ontologically primary reality is represented by a variable quantum vacuum energy density, we can provide a new re-reading of Santos' results by invoking the perspective that both the dark energy (5) and the matter density appearing in equations (27) and (30) are different aspects of the same energy of a fundamental DQV. So, in our model, taking account of Santos' results, the quantized metric of the 3D quantum vacuum condensate is expressed by relation

$$d\hat{s}^2 = \hat{g}_{\mu\nu} dx^\mu dx^\nu, \quad (32)$$

where here the (quantum operators) coefficients of the metric are defined (in polar coordinates) as

$$\begin{aligned} \hat{g}_{00} &= -1 + \hat{h}_{00}, \quad \hat{g}_{11} = 1 + \hat{h}_{11}, \quad \hat{g}_{22} = r^2 (1 + \hat{h}_{22}), \quad \hat{g}_{33} = r^2 \sin^2 \vartheta (1 + \hat{h}_{33}), \\ \hat{g}_{\mu\nu} &= \hat{h}_{\mu\nu} \text{ for } \mu \neq \nu. \end{aligned} \quad (33)$$

As regards the coefficients (33), multiplication of every term times the unit operator is implicit and, at the order  $O(r^2)$ , in the light of equation (6) one obtains

$$\langle \hat{h}_{\mu\nu} \rangle = 0 \text{ except } \langle \hat{h}_{00} \rangle = \frac{8\pi G}{3} \left( \frac{\Delta \rho_{qvE}}{c^2} + \frac{35Gc^2}{2\pi\hbar^4 V} \left( \frac{V}{c^2} \Delta \rho_{qvE}^{DE} \right)^6 \right) r^2 \text{ and}$$

$$\langle \hat{h}_{11} \rangle = \frac{8\pi G}{3} \left( -\frac{\Delta\rho_{qvE}}{2c^2} + \frac{35Gc^2}{2\pi\hbar^4 V} \left( \frac{V}{c^2} \Delta\rho_{qvE}^{DE} \right)^6 \right) r^2. \quad (34)$$

Moreover, it is assumed that the metric (32) is close to Minkowski (namely that, when the distance  $r \rightarrow \infty$ , one has  $\hat{g}_{\mu\nu} \rightarrow \eta_{\mu\nu}$ , where  $\eta_{\mu\nu}$  is the Minkowski metric) and, in equations (34),  $\Delta\rho_{qvE}^{DE}$  are opportune fluctuations of the quantum vacuum energy density which determine the dark energy density on the basis of relation

$$\rho_{DE} \cong \frac{35Gc^2}{2\pi\hbar^4 V} \left( \frac{V}{c^2} \Delta\rho_{qvE}^{DE} \right)^6. \quad (35)$$

Here, therefore, dark energy emerges as energy itself of the 3D quantum vacuum and the fluctuations of the quantum vacuum energy density play the same role of Santos' two-point correlation function. In our approach, there is an equivalence between the fluctuations of the quantum vacuum energy density and the two-point correlation function: the fluctuations of the 3D quantum vacuum energy density act as a two-point correlation function (4) on the basis of relation

$$\frac{c^4}{4\pi\hbar^4} \left( \frac{V}{c^2} \Delta\rho_{qvE}^{DE} \right)^6 \cong \int_0^\infty C(s) s ds. \quad (36)$$

The physical significance of equations (34) becomes therefore the following: on the basis of the assumption that the primary physical reality is represented by the variable energy density of DQV, and thus that the dark energy density (5) and the density of matter  $\rho_{mat}$  which appear in the metric of space of Santos' approach here are both assimilated to opportune fluctuations of a variable energy density of the same fundamental DQV, the computation of the expectation values of the quantum operators  $\hat{h}_{\mu\nu}$  turns out to be equivalent to numerical results which depend directly on the changes of the quantum vacuum energy density (as well as on the fluctuations of the quantum vacuum energy density determining the dark energy density) and this implies that the coefficients of the quantized metric (32) are indeed given by quantities depending on the changes of the quantum vacuum energy density. As regards the metric (32), it must also be emphasized that, by virtue of the behaviour of opportune and specific changes of the quantum vacuum energy density, at the atomic scale quantization is essential, but at a cosmic scale the quantum metric may be approximated by a classical metric which is the expectation of the former, in agreement with Santos' results.

The underlying microscopic geometry defining the 3D DQV generating gravity may be furthermore characterized on the basis of Gao's treatment of the quantum uncertainty principle [22] and of the hypotheses of space-time discreteness at the Planck scale in Ng's results [23-26]. Taking into account that in Ng's model the structure of the fundamental space-time foam can be inferred from the accuracy in



the measurement of a distance  $l$  – in a spherical geometry over the amount of time  $T = 2l/c$ , it takes light to cross the volume – given by

$$\delta l \geq (2\pi^2/3)^{1/3} l^{1/3} l_p^{2/3}, \quad (37)$$

by applying this discreteness hypothesis of Ng's model to Heisenberg's uncertainty relations and following [22], one obtains that the quantized metric (32) can be associated with an underlying microscopic geometry expressed by equations

$$\Delta x \geq \frac{\hbar}{2\Delta p} + \frac{\Delta p}{2\hbar} (2\pi^2/3)^{2/3} l^{2/3} l_p^{4/3}, \quad (38)$$

which is the uncertainty in the measure of the position,

$$\Delta t \geq \frac{\hbar}{2\Delta E} + \frac{\Delta E T_0^2}{2\hbar} \quad (39)$$

which is the time uncertainty and

$$\Delta L \cong \frac{(2\pi^2/3)^{1/3} l^{1/3} l_p^{2/3} T_0 E}{2\hbar} \quad (40)$$

which indicates in what sense the curvature of a region of size  $L$  can be related to the presence of energy and momentum in it. The uncertainty relations (38)-(40) are obtained by making use of a dimensional analysis which really may lead also to many other possible (infinite) final expressions; as a consequence, a possible criticism to them is that they cannot be treated as fundamental. However, it must be emphasized that, in the light of recent Gao's results, the existence of a minimum observable interval of a discrete background expressed by equations of the form (38)-(40) can provide a deeper understanding of special relativity, general relativity and quantum theory, and also have implications for the solutions to the measurement problem and the problem of quantum gravity: when combining with the uncertainty relations of the form (38)-(40), the discreteness of space may help explain why the speed of light is invariant in all inertial frames, why matter curves spacetime (showing that the dynamical relationship between matter and spacetime holds true not only for macroscopic objects but also for microscopic particles) and why the wave function collapses in agreement with experiments [27].

The quantized metric (32) of the model of the 3D DQV proposed in this chapter finally allows the quantum Einstein equations

$$\hat{G}_{\mu\nu} = \frac{8\pi G}{c^4} \hat{T}_{\mu\nu} \quad (41)$$

(where the quantum Einstein tensor operator  $\hat{G}_{\mu\nu}$  is expressed in terms of the operators  $\hat{h}_{\mu\nu}$ ) to be obtained directly. This means that the curvature of space-time characteristic of general relativity may be considered as a mathematical value which emerges from the quantized metric (32) and thus from the changes and fluctuations of the quantum vacuum energy density (on the basis of equations (33) and (34)) [6].

### 3. SAGNAC EFFECT AND DYNAMIC QUANTUM VACUUM

Sagnac effect lies in the different velocities of different light signals relative to an interferometer. Light signals coming from a source S are divided by the half-silvered-mirror HSM into two beams which follow clockwise or counter-clockwise paths, of equal length, back to HSM where they are recombined and detected at a final mirror D (see figure 6); when the interferometer is rotated with a given angular velocity, a phase shift develops between clockwise- and counter-clockwise-rotating beams owed to different times-of-passage of the light signals, which is linked to the different velocities of clockwise- and counter-clockwise-rotating light beams relative to the interferometer. Sagnac published the results of his rotating interferometer experiment in 1913 [28]. When the whole apparatus, including the light source and the detector (which in Sagnac's original experiment was a photographic plate) is rotated, a fringe shift  $\Delta Z$  is observed, corresponding, at the lowest order in the angular velocity, to a phase difference between the counter-rotating beams of

$$\Delta\varphi = 2\pi\Delta Z = 8\pi\vec{\Omega} \cdot \vec{A}/(\lambda_0 c) \quad (42)$$

where  $\vec{\Omega}$  is the angular velocity vector,  $\lambda_0$  is the vacuum wavelength of the light,  $|\vec{A}|$  is the area enclosed by the circulating light beams and  $\vec{A}$  is perpendicular to the plane of the interferometer. The fundamental space-time effect underlying the phase shift is a different transit time from beam-splitter to beam-splitter for clockwise- and counter clockwise-rotating beams, when the interferometer is rotating.

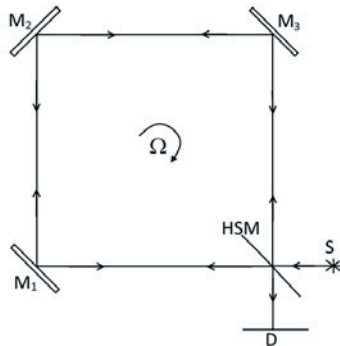

**Figure 6:** A Sagnac interferometer.

In our approach, the angular velocity  $\vec{\Omega}$  derives from the motion of the virtual particles of the **RS** processes corresponding to the elementary fluctuations of the quantum vacuum energy density, namely can be associated with the frequencies given by equation (20):

$$\vec{\Omega} = \frac{2\Delta\rho_{qvE}V}{\hbar n} \hat{r}, \quad (43)$$

where  $\hat{r}$  is the unitary vector identifying direction and versus of the angular velocity. Thus, by substituting the frequencies (20) in equation (42), this latest equation reads

$$\Delta\varphi = 16\pi \frac{\Delta\rho_{qvE}V}{\hbar n} \hat{r} \cdot \vec{A}/(\lambda_0 c). \quad (44)$$

On the basis of equation (44) we can say that the real origin, the real ultimate visiting card of the phase shift of the Sagnac interferometer is represented by motion of the virtual particles of the **RS** processes of the 3D DQV. Taking account of equation (21), equation (44) may also be written as

$$\Delta\varphi = 8\pi \frac{v_{qv}}{L} \hat{r} \cdot \vec{A}/(\lambda_0 c). \quad (45)$$

As a consequence of the frequencies (20) determined by the **RS** processes corresponding to the fluctuations of the DQV energy density, from the point of view of Galilean relativity, neglecting the displacement of the mirrors in the laboratory frame, the phase shift due to rotation of the interferometer, determined by the angular speed (45), may be written as follows:

$$\Delta\phi_{GR} = \frac{16\pi\Delta\rho_{qvE}VA}{\lambda_0\hbar nc} + O\left(\left(\frac{2\Delta\rho_{qvE}VL}{\hbar nc}\right)^3\right), \quad (46)$$

where  $A = 4L^2$  is the area enclosed by the circulating light beams.

In terms of the velocity of the quantum vacuum (21), relation (46) becomes

$$\Delta\phi_{SR} = \frac{8\pi v_{qv}A}{\lambda_0 Lc} + O\left(\left(\frac{v_{qv}}{c}\right)^3\right). \quad (47)$$

By considering the process by the point of view of special relativity, the Sagnac interference phase is a consequence of different times of arrival of the counter-rotating signals back at the HSM. The appropriate time interval is therefore that recorded by a clock co-moving with the HSM. In the laboratory frame the HSM has

a velocity of constant magnitude  $\frac{2\sqrt{2}\Delta\rho_{qvE}V}{\hbar n}L$ , corresponding to the time dilation effect:

$$\Delta T = \frac{1}{\sqrt{1-2\left(\frac{2\Delta\rho_{qvE}VL}{\hbar nc}\right)^2}} \Delta T' \quad (48)$$

which leads to relation

$$\Delta\phi_{SR} = \frac{16\pi(\Delta\rho_{qvE}V)A}{\lambda_0\hbar nc} \left[ 1 - \frac{13(\Delta\rho_{qvE})^2 V^2 L^2}{6\hbar^2 n^2 c^2} \right] + O\left(\left(\frac{2(\Delta\rho_{qvE})VL}{\hbar nc}\right)^5\right), \quad (49)$$

namely

$$\Delta\phi_{SR} = \frac{16\pi(v_{qv})A}{\lambda_0 Lc} \left[ 1 - \frac{13(v_{qv})^2}{6c^2} \right] + O\left(\left(\frac{v_{qv}}{c}\right)^5\right). \quad (50)$$

On the basis of equations (49)-(50), one can say that – as a consequence of the behaviour of the variable DQV energy density corresponding to the motion of opportune **RS** processes – special relativity contributes only an order  $\left(\frac{2\Delta\rho_{qvE}VL}{\hbar nc}\right)^2$

or, in other words,  $\left(\frac{v_{qv}}{c}\right)^2$  correction to the Sagnac phase difference as calculated in

Galilean relativity. These results obtained in the context of the 3D quantum vacuum model therefore allow us to provide a new unifying re-reading to the treatment previously made by Post [29].

It is interesting also to consider a Sagnac circular interferometer of radius  $R$  rotating with uniform angular velocity in the clockwise direction. Here, co-rotating ( $LS_+$ ) and counter-rotating ( $LS_-$ ) light signals depart simultaneously from a beam splitter (BS) when it is positioned at  $BS_0$  (see figure 7). The signals  $LS_-$  ( $LS_+$ ) arrive back at BS when it is in the laboratory frame positions  $BS_-$  ( $BS_+$ ). In the laboratory frame both light signals move with speed  $c$ . The different arrival times result from different laboratory frame path lengths followed by the signals.

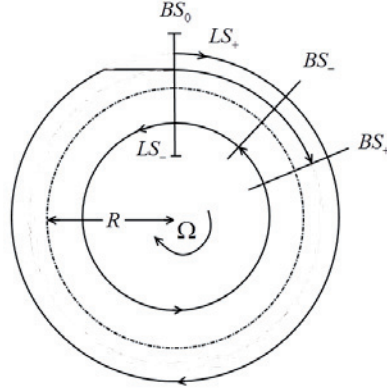

**Figure 7:** A circular Sagnac interferometer of radius  $R$  rotating with uniform angular velocity  $\Omega$  in the clockwise direction.

In this case, the relative velocities of the light signals and the interferometer, determined by the dragging effect of the quantum vacuum, are given by:

$$c_r^\pm = c \mp \left( \frac{2\Delta\rho_{qvE}VR}{\hbar n} \right), \quad (51)$$

namely

$$c_r^\pm = c \mp v_{qv}, \quad (52)$$

where  $c_r^+$  ( $c_r^-$ ) are the velocities of clockwise (counter-clockwise) rotating light signals, relative to an adjacent point on the interferometer, in the laboratory system. The times-of-passage of the light signals from beam-splitter to beam-splitter in the laboratory system for the counter-rotating signals are:

$$T_\pm = \frac{2\pi R}{c \mp \left( \frac{2\Delta\rho_{qvE}VR}{\hbar n} \right)} \quad (53)$$

namely

$$T_\pm = \frac{2\pi R}{c \mp v_{qv}}. \quad (54)$$

In the picture of Galilean relativity one has  $T_\pm = T'_\pm$ , where  $T'_\pm$  are the times of passage in the co-rotating frame of the interferometer of clockwise (counter-clockwise) rotating light signals, so the corresponding Sagnac phase shift is:

$$\Delta\phi_{GR} = \frac{16\pi\Delta\rho_{qvE}VA}{\lambda_0\hbar nc} \left[ 1 + \left( \frac{2\Delta\rho_{qvE}VR}{\hbar nc} \right)^2 \right] + O\left( \left( \frac{2\Delta\rho_{qvE}VR}{\hbar nc} \right)^5 \right), \quad (55)$$

or, in terms of the velocity of the DQV,

$$\Delta\phi_{GR} = \frac{8\pi v_{qv}A}{\lambda_0 Rc} \left[ 1 + \left( \frac{v_{qv}}{c} \right)^2 \right] + O\left( \left( \frac{v_{qv}}{c} \right)^5 \right), \quad (56)$$

where  $A = \pi R^2$ .

In a special relativistic picture, by using the differential Lorentz transformations from the laboratory system into the instantaneous co-moving frame of the beam splitter BS, one obtains the time dilation effect

$$T_{\pm}' = \frac{T_{\pm}}{\gamma}, \quad (57)$$

where

$$\gamma = \frac{1}{\sqrt{1 - \left( \frac{2\Delta\rho_{qvE}VR}{\hbar nc} \right)^2}} = \frac{1}{\sqrt{1 - \left( \frac{v_{qv}}{c} \right)^2}}, \quad (58)$$

so that the phase shift becomes

$$\Delta\phi_{SR} = \frac{16\pi\Delta\rho_{qvE}VA}{\lambda_0\hbar nc} \left[ 1 + \frac{1}{2} \left( \frac{2\Delta\rho_{qvE}VR}{\hbar nc} \right)^2 \right] + O\left( \left( \frac{2\Delta\rho_{qvE}VR}{\hbar nc} \right)^5 \right), \quad (59)$$

namely

$$\Delta\phi_{SR} = \frac{8\pi v_{qv}A}{\lambda_0 Rc} \left[ 1 + \frac{1}{2} \left( \frac{v_{qv}}{c} \right)^2 \right] + O\left( \left( \frac{v_{qv}}{c} \right)^5 \right). \quad (60)$$

In the light of the time dilation relations (57), the relative velocities of the light signals and the interferometer are not the same in the laboratory and co-rotating systems in the special relativistic case:

$$T_{\pm}' = \frac{2\pi R}{\gamma c_r^{\pm}}. \quad (61)$$

Relations (61) indicate that the times of signal flight in the co-rotating frame are determined by the motion of the virtual particles of the **RS** processes of the 3D DQV and turn out to be in agreement with calculations previously performed by Tartaglia [30]. Moreover, equations (61) show that the relative velocities of the light signals and the interferometer transform between the laboratory and co-rotating frames are

$$(c_r^\pm) = \gamma \left[ c \mp \left( \frac{2\Delta\rho_{qvE} VR}{\hbar n} \right) \right], \quad (62)$$

namely

$$(c_r^\pm) = \gamma [c \mp (v_{qv})] \quad (63)$$

which allow us to provide a new key of reading of previous results by Klauber [31]. From equations (63) it follows also

$$\frac{(c_r^+)}{(c_r^-)} = \frac{c - \left( \frac{2\Delta\rho_{qvE} VR}{\hbar n} \right)}{c + \left( \frac{2\Delta\rho_{qvE} VR}{\hbar n} \right)}, \quad (64)$$

namely

$$\frac{(c_r^+)}{(c_r^-)} = \frac{c - v_{qv}}{c + v_{qv}} \quad (65)$$

which is in agreement with Selleri's inertial transformations

$$\left\{ \begin{array}{l} x' = \frac{x_0 - vt_0}{\sqrt{1 - \beta^2}} \\ y' = y_0 \\ z' = z_0 \\ t' = \sqrt{1 - \beta^2} t_0 \end{array} \right. \quad (66)$$

which determines an arena of special relativity in which the temporal coordinate must be clearly considered as a different entity with respect to the spatial coordinates just because the transformation of clocks' run between the two inertial systems does not depend on the spatial coordinates.

In the light of the treatment of Sagnac effect based on equations (43)-(65), one can say that the different velocities of clockwise- and counter-clockwise-rotating



light beams relative to the Sagnac interferometer is really due to the motion of the virtual particles of the **RS** processes of the 3D quantum vacuum and, therefore, to the velocity of the quantum vacuum. The motion of the virtual particles which arise in the **RS** of the 3D quantum vacuum can be considered as the ultimate visiting card which determine the different velocities of clockwise- and counter-clockwise-rotating light beams relative to the Sagnac interferometer. In virtue of the motion of the virtual particles of the **RS** processes, quantum vacuum around the Earth is turning with it and – as equations (44), (46), (47), (49), (50), (51)-(65) explicitly demonstrate – this causes that the light signal between two clocks moves with higher velocity in the direction of Earth rotation and with lower velocity in the opposite direction of Earth rotation. A turning quantum vacuum in which photon moves influences its velocity (see also figure 8).

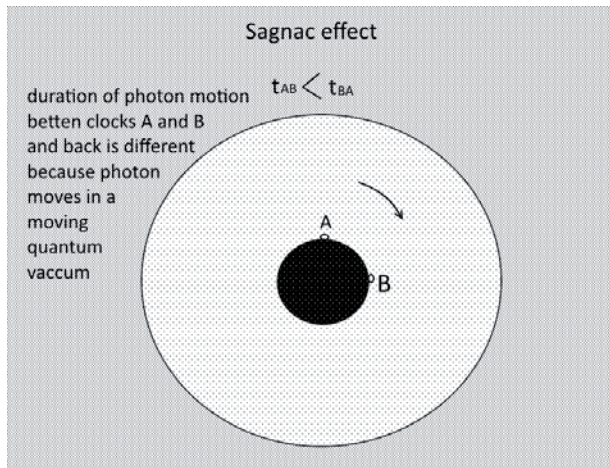

**Figure 8:** Sagnac effect by measuring light signal velocity.

As described in the papers [32, 33] Sagnac effect is routine in the operations involved in GPS providing accurate worldwide clock synchronization and timing system. As is well known, in a rotating reference frame, the Sagnac effect prevents a network of self-consistently synchronized clocks from being established by transmission of electromagnetic signals that propagate with the universally constant speed  $c$  (this is called Einstein synchronization), or by slow transport of portable atomic clocks [34]. This is a significant issue in using timing signals to determine position in the GPS. The Sagnac effect can amount to hundreds of nanoseconds; a timing error of one nanosecond can lead to a navigational error of 30 cm. The velocity of GPS microwave signals in the rest frame of a GPS receiver can be calculated according to the formula (44) above. In the picture of the 3D DQV characterized by elementary RS processes, the Sagnac correction term regarding GPS navigation, which arises when one accounts for motion of the receiver while the signal propagates from transmitter to receiver, may be expressed as

$$\Delta t_{Sagnac} = \frac{4\Delta\rho_{qvE}V}{\hbar nc^2} \hat{r} \cdot \left( \frac{1}{2} \vec{r}_R \times \vec{R} \right) \quad (67)$$

or, in equivalent way,

$$\Delta t_{Sagnac} = \frac{2v_{qv}r_R}{c^2} \hat{r} \cdot \left( \frac{1}{2} \vec{r}_R \times \vec{R} \right), \quad (68)$$

where  $\vec{r}_R$  is the receiver position (namely the vector from earth's centre to the receiver position) of a signal transmitted from the satellite position  $\vec{r}_T$  at GPS time  $t_T$ ,  $\vec{R} = \vec{r}_R - \vec{r}_T$ . In this case, the quantity  $\frac{4\Delta\rho_{qvE}V}{\hbar nc^2} = \frac{2v_{qv}r_R}{c^2}$  has the value

$$\frac{4\Delta\rho_{qvE}V}{\hbar nc^2} = 1,6227 \cdot 10^{-21} \text{ s} / \text{m}^2. \quad (69)$$

In agreement with equations (44), (46), (47), (49), (50), the last factor in equations (67)-(68) can be interpreted as a vector area  $\vec{A}$ :

$$\vec{A} = \left( \frac{1}{2} \vec{r}_R \times \vec{R} \right). \quad (70)$$

The only component of  $\vec{A}$  which contributes to the Sagnac correction is along Earth's angular velocity vector

$$\vec{\Omega} = \frac{2\Delta\rho_{qvE}V}{\hbar n} \hat{r} \quad (71)$$

due to the motion of the quantum vacuum and the orbital velocity of the Earth, because of the dot product that appears in the expression. This component is the projection of the area onto a plane normal to Earth's angular velocity vector associated with the dragging of the quantum vacuum. This leads to a simple description of the Sagnac correction (which turns out to be in agreement, for

example, with Ashby's treatment [31]):  $\Delta t_{Sagnac}$  is  $\frac{4\Delta\rho_{qvE}V}{\hbar nc^2}$  (namely  $\frac{2v_{qv}r_R}{c^2}$ )

time the area swept out by the electromagnetic pulse – determined by the motion of the quantum vacuum – as it travels from the GPS transmitter to the receiver, projected onto Earth's equatorial plane.

Similar corrections are also applied in tests, using the GPS, of the isotropy of the speed of light [35]. In this case, as also in the Michelson-Gale experiment, the 'laboratory frame', in which the speed of light is assumed [32, 33] or measured [35] to be  $c$ , is the Earth-Centered-Inertial (ECI) frame which is the co-moving inertial

frame of the centroid of the Earth with axes pointing to fixed directions on the celestial sphere. It is in this frame that the Earth's gravitational field is given by the Schwarzschild metric [36, 37] and which effectively contains the 'aether', relative to which, 'winds' were observed by Sagnac, and Michelson and Gale. It is indeed a prediction of general relativity that, in just this frame, the speed of light is (very nearly) equal to  $c$  (because of the Shapiro delay [38] of light signals crossing the Earth's gravitational field). For signals from the GPS satellites such delays are less than 200ps [32] and so give no perceptible effect in GPS operation.

For hypothetical in vacuum light signals circumnavigating the Earth at the Equator at constant distance  $R$  from the centre of the Earth the velocity of light is given by the Schwarzschild metric equation:

$$0 = \left( 1 - \frac{2G \left( \frac{V}{c^2} \cdot \Delta\rho_{qvE} \right)}{Rc^2} \right) dt^2 - \frac{R^2 d\phi^2}{c^2}. \quad (72)$$

Then the speed of the light signals in the ECI frame is

$$c_E = \left( 1 - \frac{G \left( \frac{V}{c^2} \cdot \Delta\rho_{qvE} \right)}{Rc^2} \right) c + O \left[ \left( - \frac{G \left( \frac{V}{c^2} \cdot \Delta\rho_{qvE} \right)}{Rc^2} \right)^2 \right] \quad (73)$$

which yields

$$\frac{c - c_E}{c} = 6,94 \cdot 10^{-10}. \quad (74)$$

The 'Shapiro delay' for such a light signal is then about 90ps for a round trip time of  $\frac{2\pi R}{c_E} = 134ms$ .

In order to provide an explanation of the experimental data on the propagation of microwaves near to the surface of the Earth [32, 33, 39] and the Shapiro radar echo delay experiments for microwave signals passing close to the Sun [38], in two 2001 papers Su proposed the existence of different 'effective aethers' around the Earth and the Sun in the context of a classical electromagnetic wave theory distinct from that given by special relativity [40, 41]. Here, we have shown, however, that the existence of such 'effective aethers' is a necessary consequence of general relativity in the picture of a 3D quantum vacuum which determines dragging effects as a consequence of the changes of its energy density, so that no new classical theory of the type proposed by Su is required.

#### 4. PRECESSIONS OF PLANETS ORIGINATES IN THE TURNING OF QUANTUM VACUUM

Quantum vacuum as the fundamental arena of the universe is in dynamic relation with particles and massive bodies which exist in it. The quantum vacuum around a stellar object which turns around its axis is moving with it. Region of diminished quantum vacuum energy density around a given material object or stellar body is like its “extended body” and is in a dynamic relation with outer region of quantum vacuum with higher density.

The idea about dynamic energy density of universal space which depends on the presence of stellar objects is not new. Already Newton was thinking in a similar way: "Doth not this ethereal medium in passing out of water, glass, crystal, and other compact and dense bodies in empty spaces, grow denser and denser by degrees, and by that means refract the rays of light not in a point, but by bending them gradually in curve lines? ... Is not this medium much rarer within the dense bodies of the Sun, stars, planets and comets, than in the empty celestial space between them? And in passing from them to great distances, does it not grow denser and denser perpetually, and thereby cause the gravity of those great bodies towards one another, and of their parts towards the bodies; every body endeavoring to go from the denser parts of the medium towards the rarer?" [42].

As a consequence of the motion of the virtual particles associated with an enormous amount of **RS** processes, the region of quantum vacuum around the Sun is turning together with Sun's turning and is causing precession of planets which is diminishing with the distance from the Sun and is the biggest for Mercury. In virtue of the motion of the virtual particles of the **RS** processes, the difference between velocity of the quantum vacuum and orbital velocity of the planets acts in such a way that it produces the precession of the perihelion of the planets' orbits. In this picture, the motion of the planets owing to the velocity of the quantum vacuum (associated with the motion of the virtual particles of the **RS** processes characterizing the region into consideration) can be considered the fundamental element that determines the famous test effect of the general theory of relativity. In the light of equation (21), we can say that quantum vacuum has a special property, namely a “motion effect” which is linked to the change of its energy density: when the energy density of quantum vacuum decreases, its motion effect on a stellar object is stronger and thus produces a stronger precession of this stellar object (see figure 9). The precession of each planet is caused by a specific value of the motion effect of the quantum vacuum.

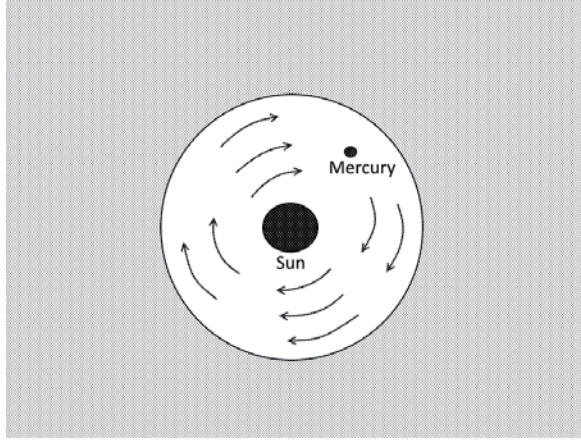

**Figure 9:** Dragging effect of quantum vacuum causes Mercury's perihelion precession.

In general theory of relativity the anomalous precessions of the planets can be derived by considering the following equation

$$\frac{d^2r}{d\tau^2} = -\frac{r_s}{r^2} + \frac{h^2}{r^3} - \frac{3h^2r_s}{r^4} \quad (75)$$

where  $\tau$  is the proper time,  $r_s$  is the gravitational radius of the Sun,  $h$  is a quantity (having the dimension of an angular momentum) determined by the initial conditions of the planet's orbit and is given by  $h = \omega r^2$  where  $\omega$  is the proper angular speed of the planet. Our Sun's mass is not nearly concentrated enough to permit this kind of orbit, since Sun's gravitational radius  $r_s$  is only 1.475 kilometres, whereas its matter fills a sphere of radius 696,000 kilometres [43].

In the approach of the 3D quantum vacuum suggested here, the fundamental events are **RS** processes corresponding to elementary fluctuations of the quantum vacuum energy density, which determine a motion of virtual particles endowed with frequencies (20) and thus giving rise to a total velocity of the quantum vacuum (21) in each given volume into consideration. Therefore, we can assume that the angular speed of each planet has two contributions, one linked to the orbital velocity of the planet  $v_p$ , the other linked to the velocity of the quantum vacuum on the planet's orbit  $v_{qv}$  (given by equation (21)):

$$\omega = \frac{v_p + v_{qv}}{r}. \quad (76)$$

By substituting (76) into (75) we obtain:

$$\frac{d^2r}{d\tau^2} = -\frac{r_s}{r^2} + \frac{(v_p + v_{qv})^2}{r^2} (r - 3r_s). \quad (77)$$

By resolving equation (77) one arrives at the solution

$$r(\phi) = \left( \frac{h^2 / r_s}{1 + 3(r_s / h)^2} \right) \frac{1}{1 + k \cos(\Omega \phi)}, \quad (78)$$

where  $k$  is a constant of integration and

$$\Omega = \frac{1}{\sqrt{1 + 6 \left( \frac{r_s}{(v_p + v_{qv})r} \right)^2}}. \quad (79)$$

By expanding  $\Omega$  one can obtain the precession per revolution as

$$\frac{2\pi}{\Omega} - 2\pi = 6\pi \left( \frac{r_s}{(v_p + v_{qv})r} \right)^2 \quad (80)$$

and thus the amount of precession for revolution depends on the velocity of the quantum vacuum that drags the planet under consideration. Moreover, by multiplying the amount of precession for revolution, given by equation (80), for the number of revolutions per century one can obtain the amount of precession for century (that can so be seen itself as a consequence of the velocity of the quantum vacuum).

In our approach, we can say that the precession of each planet is caused by a specific velocity of the quantum vacuum, which derives from the motion of the virtual particles of the **RS** processes, corresponding to fluctuations of the quantum vacuum energy density, in the region into consideration. The velocity of the quantum vacuum at the planet's orbit is determined by the diminishing of the energy density in that region, which produces a motion of the virtual particles of the **RS** processes on the basis of equation (21). Moreover, for each planet  $p$  we can define a factor of "motion effect of quantum vacuum"  $e_{mqv}$  at the planet's orbit by means of the following relation

$$e_{mqv} = \frac{|v_{qv} - v_p|}{r_p^2} \quad (81)$$

where  $v_{qv}$  is the velocity of quantum vacuum on the planet's orbit and  $v_p$  is the velocity of the planet. Taking into account equation (81), the motion effect of the quantum vacuum increases with time and decreases with the increasing of the distance from the Sun. So, for planets closer to the Sun, the velocity of the quantum vacuum at a planet's orbit turns out to be higher and therefore the motion effect of the quantum vacuum is higher and the amount of precession is higher. Instead, for planets further from the Sun, the velocity of the quantum vacuum at a planet's orbit turns out to be lower and therefore the motion effect of the quantum vacuum is lower and the amount of precession is lower.

On the basis of the elements of planetary orbits we can construct the following table showing the values of relativistic precession, the specific velocity of the quantum vacuum for each planet (in one second), and the motion effect of the quantum vacuum acting on each planet (in one second).

Planet	Velocity $v_{qv}$ of quantum vacuum in one second ( $Km/s$ )	Mean orbital velocity $v_p$ of the planet ( $Km/s$ )	Mean distance from the Sun ( $10^6 Km$ )	Mass ( $10^{24} Kg$ )	Motion effect $e_{mqv}$ of the quantum vacuum in one second ( $10^{-16} Km^{-1}s^{-1}$ )	Calculation of precession per century ( $arcs$ )
Mercury	39.3943	47.88	57.9	0.33	25.3122	42.9195
Venus	11.2807	35.02	108.2	4.87	20.2774	8.6186
Earth	5.9010	29.79	149.6	5.98	10.6742	3.8345
Mars	2.5427	24.13	227.9	0.65	4.1563	1.3502
Jupiter	0.2180	13.97	778.3	1900	0.2270	0.0623
Saturn	0.0648	9.67	1427	570	0.0472	0.0137
Uranus	0.0160	6.81	2869.6	87	0.0083	0.0024
Neptune	0.0065	5.45	4496.6	100	0.0027	0.0008
Pluto	0.0038	4.74	5900	0.7	0.0014	0.0004

It is interesting to remark that the calculations on the basis of the model here suggested lead, as regards the amounts of precession per century, to the same results as obtained by Einstein's general theory of relativity. What emerges here is the possibility of introducing a new physical entity as the ultimate source of the precessions of planets, namely the velocity of quantum vacuum (ultimately associated with the motion of the virtual particles of the **RS** processes corresponding to the changes of the DQV energy density) and thus of providing a new suggestive key of reading the results of general relativity.

## 5. ABOUT SHAPIRO EXPERIMENT, GEODETIC EFFECT, DRAGGING EFFECT AND ENERGY DENSITY OF DYNAMIC QUANTUM VACUUM

Besides perihelion-shift, another classic "test" of general relativity is represented by the time delay of light signals in a gravitational field. In this regard, in 1964 Irwin Shapiro realized that if general relativity was correct, a light signal sent across the



solar system past the sun to a planet or satellite would be slowed in the Sun's gravitational field by an amount proportional to the light-bending factor,  $\frac{1+\gamma}{2}$  (where  $\gamma$  is the Eddington parameter measuring the distortion of space to first order, which, according to various observations, is predicted to satisfy  $|\gamma-1| < 2.3 \cdot 10^{-5}$ ) and that it would be possible to measure this effect if the signal were reflected back to Earth. Typical time delays are on the order of several hundred microseconds; this is sometimes referred to as the "fourth classical test" of general relativity. Passive radar reflections from Mercury and Mars were consistent with general relativity to an accuracy of about 5%. Use of the Viking Mars lander as an active radar re-transmitter in 1976 confirmed Einstein's theory at the 0.1% level. Other targets included artificial satellites such as Mariners 6 and 7 and Voyager 2, but the most precise of all Shapiro time delay experiments involved Doppler tracking of the Cassini spacecraft on its way to Saturn in 2003; this limited any deviations from general relativity to less than 0.002%, the most stringent test of the theory so far.

In our model velocity of light by Shapiro effect is diminished for a minimal amount because of diminished energy density of quantum vacuum near stellar objects. Diminished energy density of DQV  $\rho_{qv}$  close to the stellar object with mass diminishes permeability  $\mu_0$  and permittivity  $\epsilon_0$  of "free space" and this determines a diminishing of the velocity of light:  $\rho_p \rightarrow c = \frac{1}{\epsilon_0 \cdot \mu_0}$ ,  $\rho_{qv} \rightarrow c = \frac{1}{\sqrt{\epsilon \cdot \mu}}$ . It is valid in general that velocity of changes (rate of clocks and velocity of light included) diminishes with the diminishing of energy density of quantum vacuum.

Furthermore, radio astronomy provided another famous test of general relativity in the form of the binary pulsar. General relativity predicts that a non-spherically-symmetric system (such as a pair of masses in orbit around each other) will lose energy through the emission of gravitational waves. While these waves themselves have not yet been detected directly, the loss of energy has. The evidence comes from binary systems containing at least one pulsar. Pulsars are rapidly rotating neutron stars that emit regular radio pulses from their magnetic poles. These pulses can be used to reconstruct the pulsar's orbital motions. The fact that these objects are neutron stars makes them particularly valuable as experimental probes because their gravitational fields are much stronger than those of the Sun (thus providing arguably "moderate-field" tests of general relativity, in the regime of weak fields in the sense that  $Gm/c^2r \approx 1$ , namely  $GV \cdot \Delta\rho_{qvE} / c^4r \approx 1$ ). The first binary pulsar was discovered by R.A. Hulse and J.H. Taylor in 1974. Timing measurements produce three constraints on the two unknown masses plus one more quantity; when applied to the general-relativistic energy loss formula, the results are consistent at the 0.2% level. Several other relativistic binary systems have since been discovered, including one whose orbital plane is seen almost edge-on and another in which the companion is probably a white dwarf rather than a neutron star. Most compelling is a *double pulsar* system, in which radio pulses are detected from both stars. This imposes six constraints on the two unknown masses and allows for four independent tests of general relativity.

The fact that all four are mutually consistent is itself impressive confirmation of the theory. After two and a half years of observation, the most precise of these tests (time delay) verifies Einstein's theory to within 0.05%.

On the other hand, in 1960 Schiff showed that an ideal gyroscope in orbit around the Earth would undergo two relativistic precessions with respect to a distant inertial frame: (1) a geodetic drift in the orbit plane due to motion through the space-time curved by Earth's mass and (2) a frame-dragging precession due to Earth's rotation [44]. This means, in other words, that general relativity predicts two fundamental phenomena: the geodetic effect, according to which the spin axis of a rotating test body precess in a gravitational field (namely a curved spacetime around a massive object causes an orbiting gyroscope to precess about an axis perpendicular to the plane of its motion), and the frame-dragging effect, according to which a rotating object pulls spacetime around with it, twisting the spin axis of a gyroscope along the equatorial plane. In the framework of a gravito-electromagnetic analogy, the geodetic effect can be seen partly as a spin-orbit interaction between the spin of the gyroscope and the "mass current" of the rotating object; the frame-dragging effect is a manifestation of the spin-spin interaction between the test body and the central mass. Gravity Probe B, launched 20 April 2004, can be considered as the first space experiment of general relativity to produce direct and unambiguous detections of the geodetic effect and the frame-dragging effect. Data collection started 28 August 2004 and ended 14 August 2005. Analysis of the data from all four gyroscopes of this space experiment results in a geodetic drift rate of  $-6601.8 \pm 18.3 \text{ mas/yr}$  and a frame-dragging drift rate of  $-37.2 \pm 7.2 \text{ mas/yr}$ , to be compared with the general relativistic predictions of  $-6606.1 \text{ mas/yr}$  and  $-39.2 \text{ mas/yr}$ , respectively (where  $1 \text{ mas} = 4.848 \cdot 10^{-9} \text{ rad}$ ). Results of the Gravity Probe B experiment are thus in agreement with the predictions of general relativity for both the geodetic precession and the frame-dragging precession.

The precession due to the geodetic effect and the frame-dragging effect is given by Schiff's formula

$$\vec{\Omega}_{GR} = \vec{\Omega}_g + \vec{\Omega}_{fd} = \frac{3GM}{2c^2 r^3} (\vec{r} \times \vec{v}) + \frac{GI}{c^2 r^3} \left[ \frac{3\vec{r}}{r^2} (\vec{S} \cdot \vec{r}) - \vec{S} \right] \quad (82)$$

where  $M$ ,  $I$  and  $\vec{S}$  are mass, moment of inertia and angular momentum of the central body while  $\vec{r}$  and  $\vec{v}$  are the radial position and instantaneous velocity of the test body. The frame-dragging or S-dependent term in equation (82), which reveals clearly the Machian aspect of Einstein's theory, is smaller in magnitude than the geodetic one. For whatever reason, frame-dragging within general relativity was first discussed that same year by Austrian physicists Hans Thirring and Josef Lense; it is often referred to as the Lense-Thirring effect. Thirring originally approached this problem as an experimentalist; he hoped to look for Mach-type dragging effects inside a massive rotating cylinder. Unable to raise the necessary financing, he reluctantly settled down to solve the problem theoretically instead [45]. It is his second calculation (with Lense) involving the field outside a slowly rotating solid sphere that forms the basis for modern gyroscopic tests. But both his results are

“Machian” in the sense that the inertial reference frame of the test particle is influenced by the motion of the larger mass (the cylinder or sphere). This is completely unlike Newtonian dynamics, where local inertia arises entirely due to motion with respect to “absolute space” and is not influenced by the distribution of matter.

In terms of the gravito-electromagnetic analogy, frame-dragging is a manifestation of the spin–spin interaction between the test body and central mass. In the case of Gravity Probe B, a test body with spin  $S$  experiences a torque proportional to  $\vec{S} \times \vec{H}$ , where  $\vec{H}$  is the gravitomagnetic field obeying equation

$$\vec{\nabla} \times \vec{H} = -\frac{4\pi G}{c^2} 2\vec{j} + \frac{1}{c^2} \frac{\partial \vec{g}}{\partial t}, \quad (83)$$

( $\vec{g}$  representing the gravitostatic field, namely the “ordinary” Newtonian field and  $\vec{j}$  being the ordinary mass current density), which causes the gyroscope spin axes to precess in the east-west direction by 39 milliarcseconds per year – an angle so tiny that it is equivalent to the average angular width of the dwarf planet Pluto as seen from the Earth.

The orbital plane of an artificial satellite is also a kind of “gyroscope” whose nodes (the points where it intersects a reference plane) will exhibit a similar frame-dragging precession (the de Sitter effect). Such an effect has been reported in the case of the Earth-orbiting Laser Geodynamic Satellites (LAGEOS and LAGEOS II) by Ignazio Ciufolini and colleagues using laser ranging [46, 47]. Both in the Lageos and in the Gravity Probe B experiments the relevant parameter which determines the angular velocities of the gyroscopes is

$$\frac{GM_E}{c^2 R} \approx 10^{-9}. \quad (84)$$

In [48] Adler has shown that the predictions of the gyro precession in the Gravity Probe B experiment can be reproduced in a coherent picture in terms of the following three fundamental elements of gravity theory: firstly, that macroscopic gravity is described by a metric theory such as general relativity, secondly that the Lense–Thirring metric provides an approximate description of the gravitational field of the spinning earth, and thirdly that the spin axis of a gyroscope is parallel displaced in spacetime, which gives its equation of motion. On the basis of Adler’s treatment, the agreement of Gravity Probe B with theory strengthens the belief that all these three elements of gravity theory are correct and constitutes thus an important proof of the success of general relativity in the description of astrophysical phenomena.

By following Adler [48], in the Lense–Thirring metric

$$ds^2 = (1 - 2m/r)dt^2 - (1 + 2m/r)dr^2 + 2\left(\frac{2GJ}{r}\right)\sin^2\theta d\varphi dt, \quad (85)$$

( $J$  being the angular momentum of the spinning source body), which in the gravito-magnetic approximation may be conveniently expressed as

$$ds^2 = (1 - 2\phi)dt^2 - (1 + 2\phi)dr^2 + 2(\vec{H} \cdot d\vec{r})dt \quad (86)$$

$\phi$  being the Newtonian potential outside the body, the spin equation for Gravity Probe B is

$$\dot{\vec{S}} = \left( \vec{\Omega}_G + \vec{\Omega}_{LT} \right) \times \vec{S}, \quad (87)$$

where  $\vec{\Omega}_G$  is the geodetic vector field

$$\vec{\Omega}_G = (\gamma + \alpha/2)(\nabla\phi \times \vec{v}), \quad (88)$$

$\vec{\Omega}_{LT}$  is the gravito-magnetic vector potential

$$\vec{\Omega}_{LT} = \frac{1}{4}(\gamma + \alpha)(\nabla \times \vec{H}), \quad (89)$$

$\alpha$  being the Eddington parameter measuring the distortion of time due to gravity.

For the Gravity Probe B gyro the precession is extremely slow, so the spin does not change appreciably over the course of many orbits, and we may write the change in  $\vec{S}$  in time  $\Delta t$  as

$$\Delta\vec{S} = \left( \vec{\Omega}_G \times \vec{S} \right) \Delta t + \left( \vec{\Omega}_{LT} \times \vec{S} \right) \Delta t \quad (90)$$

with  $\vec{S}$  treated as a constant. As regards the geodetic term of (90) which is by far the larger part, since for a circular orbit the gravitational force and the velocity are perpendicular and thus the geodetic field is perpendicular to the orbit plane, the geodetic vector and its magnitude are

$$\vec{\Omega}_G = (\gamma + \alpha/2) \left( \frac{GM}{r^2} \right) (\hat{r} \times \vec{v}), \quad (91)$$

$$\Omega_G = (\gamma + \alpha/2) \left( \frac{GMv}{r^2} \right). \quad (92)$$

The Lense-Thirring precession depends on the gravito-magnetic field  $\vec{\Omega}_{LT}$ , which varies with position in the orbit. The gravito-magnetic vector potential  $\vec{H}$  of the spinning Earth can be calculated in the same way as the vector potential of a spinning ball of charge in electrodynamics. The results are the following:

$$\vec{H} = \left( \frac{2G}{r^3} \right) (\vec{r} \times \vec{J}), \quad (93)$$

$$\vec{\Omega}_{LT} = \frac{1}{2} (\gamma + \alpha) G \left( \frac{\vec{J}}{r^3} - \frac{3\vec{r}}{r^5} (\vec{r} \cdot \vec{J}) \right), \quad (94)$$

where  $\vec{J}$  is the angular momentum of the Earth. In this way, according to Adler's results, the Lense–Thirring precession may be obtained directly by only averaging  $\vec{\Omega}_{LT}$  over an orbit.

According to our model of 3D DQV, the mass of the central body is determined by a corresponding diminishing of the quantum vacuum energy density, which acts on the test body motions; as a consequence, Schiff's formula (82) may be conveniently expressed as

$$\vec{\Omega}_{GR} = \vec{\Omega}_g + \vec{\Omega}_{fd} = \frac{3GV \cdot \Delta\rho_{qvE}}{2c^4 r^3} (\vec{r} \times (\vec{v}_p + \vec{v}_{qv})) + \frac{GI(\Delta\rho_{qvE})}{c^2 r^3} \left[ \frac{3\vec{r}}{r^2} (\vec{S} \cdot \vec{r}) - \vec{S} \right] \quad (95).$$

On the basis of equation (95), the geodetic effect of general relativity is directly determined by the motion effect of the quantum vacuum energy density (associated ultimately with the motion of the virtual particles of the **RS** processes characterizing the region into consideration) and, because of the indirect dependence of the moment of inertia of the central body on the changes of the quantum vacuum energy density, also the frame-dragging effect implicitly depends on the quantum vacuum energy density. Moreover, taking account of Adler's results, the geodetic vector field (88) may be written as

$$\vec{\Omega}_G = (\gamma + \alpha/2) (\nabla\phi \times (\vec{v}_p + \vec{v}_{qv})) \quad (96)$$

which, in the case of a circular orbit, becomes

$$\vec{\Omega}_G = (\gamma + \alpha/2) \left( \frac{GV \cdot \Delta\rho_{qvE}}{c^2 r^2} \right) (\hat{r} \times (\vec{v}_p + \vec{v}_{qv})) \quad (97)$$

whose magnitude is

$$\Omega_G = (\gamma + \alpha/2) \left( \frac{GV \cdot \Delta\rho_{qvE} (v_p + v_{qv})}{c^2 r^2} \right). \quad (98)$$

Finally, also the gravito-magnetic vector potential (94), because of its dependence on the angular momentum of the Earth, is linked with the motion effect of the quantum vacuum and the changes of the quantum vacuum energy density. In synthesis, according to our model of 3D DQV, Adler's relations regarding the

geodetic effect and the Lense–Thirring precession, namely equations (88)-(94), may be seen as a consequence of more fundamental changes of the quantum vacuum energy density.

## 6. ENERGY DENSITY OF QUANTUM VACUUM AND RELATIVE VELOCITY OF CLOCKS

Energy density of DQV is at its minimum in the centre of a stellar object and increases by distance from the centre according to the formalism (10). Diminished energy density of quantum vacuum causes clocks run slower on the Earth surface than on GPS satellites. It is valid in general that velocity of changes (rate of clocks and velocity of light included) diminishes with the diminishing of energy density of quantum vacuum.

Because of the well-known general relativity effect, rate of clocks is slower on the surface of the earth than on the GPS satellites for  $45,7 \mu s$  per day. Because of special relativity effect, rate of clocks is slower on the GPS satellite than on the surface of the earth for  $7,1 \mu s$  per day [49].

By considering the Schwarzschild metric

$$c^2 d\tau^2 = \left(1 - \frac{r_s}{r}\right) c^2 dt^2 - \left(1 - \frac{r_s}{r}\right)^{-1} dr^2 + r^2 d\vartheta^2 - r^2 \sin^2 \vartheta d\varphi^2 \quad (99)$$

where  $r_s$  is the Schwarzschild radius (corresponding to the change of the quantum vacuum energy density  $\Delta\rho_{qvE} = \rho_{pE} - \rho_{qvE}$ ) the gravitational time dilation of general relativity, in the vicinity of a non-rotating massive spherically symmetric object, may be expressed as:

$$\tau_0 = \tau_f \left(1 - \frac{r_s}{r}\right)^{1/2} \quad (100)$$

where  $\tau_0$  is the proper time between events A and B for a slow-ticking observer within the gravitational field,  $\tau_f$  is the coordinate time between two given events A and B for a fast-ticking observer at an arbitrarily large distance from the massive object (this assumes the fast-ticking observer is using Schwarzschild coordinates, a coordinate system where a clock at infinite distance from the massive sphere would tick at one second per second of coordinate time, while closer clocks would tick at less than that rate),  $r$  is the radial coordinate of the observer (which is analogous to the classical distance from the center of the object, but is actually a Schwarzschild coordinate).

In particular, if we consider the propagation of pulsed signals in a Schwarzschild space-time which are emitted at events 1 and 2 on radius  $r_E$  and received at events 3 and 4 on radius  $r_R$ , with  $r_R > r_E$ , one obtains

$$d\tau_R / d\tau_E = \left(1 - \frac{r_S}{r_R}\right)^{1/2} / \left(1 - \frac{r_S}{r_E}\right)^{1/2}, \quad (101)$$

where  $d\tau_R / d\tau_E > 1$ . Equation (101) indicates that the proper time interval between signal pulses at the receiver is longer than the interval at the emitter; equivalently, the signal frequency at the receiver is lower than at the emitter (this is the well known gravitational red shift, which can be attributed to the different gravitational potentials at the transmitter and receiver and thus to the different behaviours of the quantum vacuum energy density at the transmitter and receiver and is expressed in a proper time ratio).

We can thus conclude that between an event pair at the receiver the associated clock records a longer velocity of change than the corresponding velocity of change recorded at the emitter. In other words, according to a given time standard, there is more velocity of change between an event pair at the receiver than there is between the corresponding events at the emitter. In both special relativity and general relativity, we employ time intervals on standard clocks running at the standard rate. On what might be called the usual view in special relativity, clocks are said to be slowed on account of their motion, but no satisfactory explanation, or calculation, has ever been given. In general relativity, a clock in a stronger gravitational field is said to run more slowly – again, a notion exists that the clock is in some way affected.

By considering what we mean by the rate of a clock and the amount of time between given event pairs in the picture of our 3D DQV model, our conclusion is that clocks (and consequently also rods) are not affected in Relativity Theory. Clocks do not go slow and rods do not contract. In Dynamic Quantum Vacuum Relativity (DQVR) changes run in quantum vacuum only and not in time. “Relative” is velocity of change which depends on the energy density of quantum vacuum. Changes (and clocks) do not run in time; duration of changes is time. In DQVR time is a fundamental quantity of the universe which has only a mathematical existence. DQV itself is “timeless” in a sense time is not its 4<sup>th</sup> dimension [50].

## 7. DYNAMIC QUANTUM VACUUM MODEL AND COSMOLOGY

Energy density of DQV is at its minimum in the centre of a stellar object and increases by distance from the centre according to the formalism (10).

In DQV which is the fundamental arena of the universe time is merely a mathematical parameter measuring numerical order of change, i.e. motion. Past,



present and future are not physical realities which can be associated to a 4<sup>th</sup> dimension of space, they are only emergent realities which have a mathematical existence [51]. Universe exists in what Albert Einstein used to call NOW: "...there is something essential about the NOW which is just outside the realm of science. People like us, who believe in physics, know that the distinction between the past, present and future is only a stubbornly persistent illusion" [52].

Our model of DQV allows us to bring Einstein's NOW inside the realm of physics. DQV is always NOW in which past, present, future have only a mathematical existence. In this picture, common understanding of the Big bang cosmology where universe is expanding in time as a physical reality (see figure 10) cannot be considered appropriate any more.

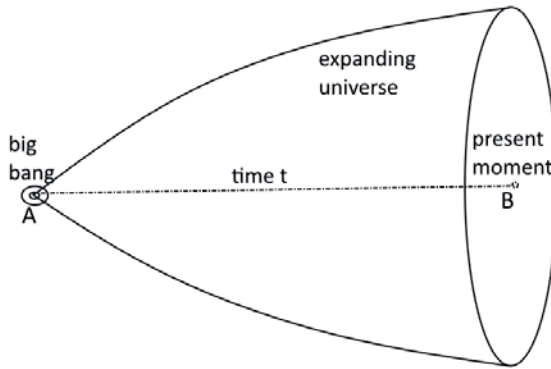

**Figure 10:** Classical image of Big bang cosmology.

Universe exists in DQV which is NOW. Universe is timeless in a sense that time is not a physical dimension in which universe exists. This view is also confirmed by the well-known research of Kurt Gödel. By 1949, Gödel had remarked: "In any universe described by the Theory of Relativity, time cannot exist" [53]. Gödel discovered that closed "time-lines" in general relativity allow hypothetical travels in time which lead to contradictions. Considering time has only mathematical existence there are no contradictions, one can travel in DQV only and time is duration of this motion.

Model of the universe where time is only a mathematical parameter of change, i.e. motion requires the re-reading of some experimental data. Considering that universe exists in physical time, the interpretation that cosmic microwave background radiation (CMB) has a source 380,000 years after big bang makes sense because time  $t$  is a physical dimension which relates big bang (namely point A on the figure 10) with present moment (namely point B on the figure 10) in which we measure CMB, in other words time is a transmitter of CMB. Considering that universe exists in DQV which is NOW, CMB cannot have its source in some hypothetical physical past and time cannot be transmitter of CMB. The source of CMB is present in the actual universe that we observe.



Considering that universe is NOW also existence of one single big bang and eternal expansion of the universe is questionable. The only reasonable cosmological model based on big bang seems a cyclic universe where big bang is followed by expansion which stops at a certain period and universe starts collapsing in a big crunch which explodes in a new big bang. We propose a model of universe in a dynamic equilibrium with no beginning and no end with a permanent energy flow which has origin in variable energy density of DQV (see Figure 4).

In our model of DQV which is NOW, also BICEP2 model of gravitational waves as ripples of space-time which have origin in big bang becomes questionable [54]. The idea of BICEP2 is that gravitational waves are born at big bang (on the figure 10, at the point A) and are expanding in physical time till the present moment (on the figure 10, at the point B). Considering time is not a physical dimension in which universe expands, time cannot transmit gravitational waves or any other signal which can be transmitted only via DQV where time is a duration of its motion from point A to point B. If gravitational waves exist, they should have origin in DQV which is NOW, namely in a source which is present in the universe we observe. On the other hand, the “B-mode” polarizations of the cosmic microwave radiation observed by the BICEP telescope at the South Pole seem most likely to be “local” galactic contamination rather than an imprint left behind by the rapid “inflation” of the early universe [55].

In our model gravity is a result of fundamental symmetry between a given particle or material object and diminished energy density of DQV. In order to describe gravity our model does not require existence of hypothetical graviton nor existence of gravitational waves. According to Newton’s model gravity is not a propagating phenomenon with duration as light is; gravity is immediate. That’s why in Newton’s formalism for gravity time does not appear. Also in general relativity time is only a mathematical parameter of stress-energy tensor; gravity has origin in curvature of space and is immediate. Our model does not predict existence of hypothetical graviton nor existence of gravitational waves. Gravity is not a propagating phenomenon with duration as light is, gravity is immediate. In this picture, comparing hypothetical graviton with photon does not seem appropriate also because it considers gravity requires motion and so time.

## 8. PERSPECTIVES AND CONCLUSIONS

A model of a three-dimensional quantum vacuum has been proposed in which the curvature of space-time emerges, in the hydrodynamic limit of some underlying theory of a microscopic structure of space-time, as a mathematical value of a more fundamental actual energy density of quantum vacuum.

In this article mass is presented as a result of a dynamics between a given particle or massive body and the dynamic quantum vacuum in which the particle or the massive body exists. The concept of mass presented in this paper answers the

question what gives mass to the Higgs boson itself [56]. In our model gravity is a result of the pressure of outer quantum vacuum with higher energy density in the direction of quantum vacuum with lower energy density due to existence of a given particle or massive object. This model is valid from the scale of elementary particles to the scale of stellar objects.

NASA research shows that universal space is flat with only a 0.4% margin of error: “Recent measurements (c. 2001) by a number of ground-based and balloon-based experiments, including MAT/TOCO, Boomerang, Maxima, and DASI, showed that the brightest spots are about 1 degree across. Thus the universe was known to be flat to within about 15% accuracy prior to the WMAP results. WMAP has confirmed this result with very high accuracy and precision. We now know (as of 2013) that the universe is flat with only a 0.4% margin of error. This suggests that the Universe is infinite in extent; however, since the Universe has a finite age, we can only observe a finite volume of the Universe. All we can truly conclude is that the Universe is much larger than the volume we can directly observe” [57].

NASA results strongly indicate that curvature of space in general theory of relativity is only a mathematical description of energy density of universal space which originates in energy density of quantum vacuum. The development of a mathematical model which will connect energy density of quantum vacuum, curvature of space in general relativity and Higgs field is currently in progress and, in this connection, the geometro–hydrodynamic model of space-time as a condensate could give an important contribution in the understanding of quantum vacuum since, if the Universe as a whole should be a quantum object (whose large scale behaviour is controlled by a classic–like equation such the Gross–Pitaevsky equation in Bose–Einstein Condensate theory [58]), the existence of vacuum energy density characterizing it as a quantum system could be immediately explained, unlike what happens in the generally accepted point of view in which it remains substantially mysterious. Obviously further researches and developments are necessary and in progress in this direction, above all as regards the formulation of a complete dynamical model regarding the behavior of the quantum vacuum energy density.

The general concept of the Standard Model is to describe the four fundamental forces with elementary particles and to explain the mass of the elementary particles with the Higgs boson. As this model does not give completely satisfying results yet, on the basis of the treatment of this paper, according to the authors it seems plausible and legitimate to suggest that mass and gravity originate from the diminishing of the energy density of a dynamic quantum vacuum condensate characterized by a quantized metric, caused by a given material object or particle. Physical phenomena of inertial mass, gravitational mass and gravity have origin in the dynamics between the underlying arena of the universe represented by the 3D dynamic quantum vacuum and existing particle or massive object. This model can be applied from the scale of the photon to the scale of a centre of the galaxy and has the merit to describe the mass of every elementary particle including the Higgs boson too. Furthermore, it is compatible with the dynamic space mathematically described by general relativity in the low energy–long wavelength limit of the behaviour of timeless dynamic quantum vacuum.

## REFERENCES

1. Timashev S. F., Physical vacuum as a system manifesting itself on various scales – from nuclear physics to cosmology, arXiv:1107.pdf [gr-qc] (2011).
2. Rovelli C., *Physics World* **7**, 11, 1–5 (2003).
3. Rovelli C., Loop quantum gravity, <<http://relativity.livingreviews.org/Articles/lrr-2008-5/>> (2008).
4. Rovelli C., A new look at loop quantum gravity, <arXiv:1004.1780v1 [gr-qc]> (2010).
5. Fisaletti D. and Sorli A., *SOP Transactions on Theoretical Physics* **1**, 3, 11–38 (2014).
6. Fisaletti D. and Sorli A., *Annales UMCS, Sectio AAA: Physica* **69**, 55–81 (2014).
7. <https://einstein.stanford.edu/content/education/lithos/litho-fd.pdf>.
8. Sato M. A revisit of the papers on the theory of relativity: Reconsideration of the hypothesis of ether-dragging, <http://arxiv.org/abs/0704.1942> (2009).
9. Sorli A., Fisaletti D. and Gregl T., *Physics Essays* **26**, 1, 113–115 (2013).
10. Caligiuri L.M. and Sorli A., *American Journal of Modern Physics* **3**, 2, 51–59 (2014).
11. Santos E., *International Journal of Theoretical Physics* **50**, 7, 2125–2133, DOI 10.1007/s10773-010-0633-6 (2010).
12. Zeldovich Yu B., *Zh. Eksp. & Teor. Fiz. Pis'ma* **6**, 883–884 (1967).
13. Rueda A. and Haisch B., Gravity and the quantum vacuum inertia hypothesis, arXiv:gr-qc0504061v3 (2005).
14. Chiatti L., The transaction as a quantum concept, in: *Space-time geometry and quantum events*, I. Licata ed., pp. 11–44 (Nova Science Publishers, New York, 2014); e-print [arXiv.org/pdf/1204.6636](http://arxiv.org/pdf/1204.6636) (2012).
15. Licata I., Transaction and non-locality in quantum field theory, *European Physical Journal Web of Conferences* (2013).
16. Sbitnev V., From the Newton's laws to motion of the fluid and superfluid vacuum: vortex tubes, rings, and others, arXiv:1403.3900v2 [physics.flu-dyn] (2014).
17. Sbitnev V., *Modern Physics Letters A* **30**, 35, 1550184 (2015); e-print arXiv:1507.03519v1 [physics.gen-ph].
18. Sbitnev V.I., Physical vacuum is a special superfluid medium, in: *Selected Topics in Applications of Quantum Mechanics*, M.R. Pahlavani ed., pp. 345–373, InTech, Rijeka (2015).
19. Sbitnev V.I., Navier-stokes equation describes the movement of a special superfluid medium, *Foundations of Physics*, in press, 2015; e-print <http://arxiv.org/abs/1504.07497>.
20. Volovik G.E., *The Universe in a Helium Droplet*, Clarendon Press, Oxford (2003).
21. Friedlander M. W., *A Thin Cosmic Rain: Particles from Outer Space*, Harvard University Press, Harvard (2002).
22. Gao S., Why gravity is fundamental, arXiv:1001-3029v3 (2010).
23. Jack Y. Ng, *Physics Letters B* **657**, 1, 10–14 (2007).
24. Jack Y. Ng, *Entropy* **10**, 441–461 (2008).
25. Jack Y. Ng, Holographic quantum foam, arXiv:1001.0411v1 [gr-qc] (2010).
26. Jack Y. Ng, Various facets of spacetime foam, arXiv:1102.4109.v1 [gr-qc] (2011).

27. Gao S., Three possible implications of spacetime discreteness, [http://philsci-archive.pitt.edu/9966/1/three\\_implications\\_of\\_spacetime\\_discreteness\\_2013\\_v6.pdf](http://philsci-archive.pitt.edu/9966/1/three_implications_of_spacetime_discreteness_2013_v6.pdf) (2013).
28. Sagnac G., *Comptes Rendus* **157**, 708–710 and 1410–1413 (1913).
29. Post E. J., *Reviews of Modern Physics* **39**, 2, 475–493 (1967).
30. Tartaglia A., in: *Relativity in Rotating Frames*, G. Rizzi and M. L. Ruggiero eds., Kluwer Academic Publishers, Dordrecht (2004).
31. Klauber R. D., *Foundations of Physics Letters* **16**, 5, 447–463 (2003).
32. Ashby N., *Physics Today* **55**, 5, 41–47 (2002).
33. Allan D. W., Weiss M. A. and Ashby N., *Science* **228**, 64–70 (1985).
34. Landau L. and Lifshitz E., *The Classical Theory of Fields*, 4th ed., Pergamon, New York (1997).
35. Wolf P. and Petit G., *Physical Review A* **56**, 4405–4409 (1997).
36. K. Schwarzschild, *Sitzungsberichte Prüssische Akademie der Wissenschaften*, p. 198 (1916).
37. Weinberg S., *Gravitation and Cosmology, Principles and Applications of the General Theory of Relativity*, John Wiley, New York (1972).
38. Shapiro I. et al., *Physical Review Letters* **26**, 18, 1132–1135 (1971).
39. Saburi Y., Yamamoto M. and Harada K., *IEEE Trans. Instr. Meas.* **25**, 4, 473–477 (1976).
40. Su C.-C., *Europhysics Letters* **56**, 2, 170–174 (2001).
41. Su C.-C., *European Journal of Physics C* **21**, 4, 701–715 (2001).
42. Newton I., *The Third Book of Optics*, <http://www.newtonproject.sussex.ac.uk> (1718).
43. Brown K., *Reflections on Relativity*, Amazon (2011), pp. 421–431.
44. Schiff L. I., *Physical Review* **4**, 5, 215–217 (1960).
45. Pfister H., Dragging effects near rotating bodies and in cosmological models, in: J. B. Barbour and H. Pfister eds., *From Newton's Bucket to Quantum Gravity*, Birkhäuser, p. 315, Boston (1995).
46. Ciufolini I. et al., *Science* **279**, 5359, 2100–2103 (1998).
47. Ciufolini I. and Pavlis E. C., *Nature* **431**, 7011, 958–960 (2004).
48. Adler R. J., The three-fold theoretical basis of the Gravity Probe B gyro precession calculation, arXiv:1405.5511v1 [gr-qc] (2014).
49. Sato M., Interpretation of the slight periodic displacement in the Michelson-Morley experiments, <http://arxiv.org/abs/physics/0605067> (2006).
50. Fisaletti D. and Sorli A., Bijective epistemology and space-time, *Foundations of Science* **20**, 4, 387–398, (2015).
51. Fisaletti D. and Sorli A., Perspectives of the Numerical Order of Material Changes in Timeless Approaches in Physics, *Foundations of Physics* **45**, 2, 105–133 (2015).
52. Sorli A., *The Physics of NOW*, Amazon (2014).
53. Yourgrau P., *A World Without Time: The Forgotten Legacy of Godel and Einstein*, Basic Books, New York (2006); available at [http://findarticles.com/p/articles/mi\\_m1200/is\\_8\\_167/ai\\_n13595656](http://findarticles.com/p/articles/mi_m1200/is_8_167/ai_n13595656).

54. BICEP 2 <http://bicepkeck.org/>.
55. <http://physicsworld.com/cws/article/news/2014/sep/22/bicep2-gravitational-wave-result-bites-the-dust-thanks-to-new-planck-data> (2014).
56. Wilczek F., Origins of Mass, <http://arxiv.org/pdf/1206.7114.pdf> (2012).
57. NASA, [http://map.gsfc.nasa.gov/universe/uni\\_shape.html](http://map.gsfc.nasa.gov/universe/uni_shape.html) (2013).